

# **KODEN**

## **OPERATION MANUAL**

---

### **MARINE RADAR**

# **MDC-900**

## **SERIES**

This product is specifically designed to be installed on boats and other means of maritime transport. If your country forms part to the EU, please contact your dealer for advice before attempting to install elsewhere.



**MDC-900 Series Operation Manual****Doc No. 0093142132****Document Revision History**

No.	Doc. No / Rev. No.	Revised Date (Y/M/D)	Revised Content
0	0093142132-00	2008/07/18	First edition
1	0093142132-01	2008/11/10	Total revision
2	0093142132-02	2009/05/22	Chapter 5
3	0093142132-03	2010/02/18	Total revision
4	0093142132-04	2011/04/11	Total revision
5	0093142132-05	2011/09/30	Chapter 2, Chapter 3, Chapter 6
6	0093142132-06	2013/12/04	Chapter 2, Chapter 6
7	0093142132-07	2015/02/17	Disposal of used cell and this radar
8	0093142132-08	2015/05/19	Break in procedure of stored radar Deleted "Disposal of used cell and this radar"
9	0093142132-09	2017/02/06	Deleted Declaration, Configuration of Equipment, Chapter 3, Chapter 5, Cover
10	0093142132-10	2018/02/27	For Your Safe Operation, Chapter 5
11	0093142132-11	2018/12/25	Chapter 5

**Document No. Revised Version Norm**

When part of the document needs to be revised, the document has advanced revision number.

The document No. is indicated at the lower right side on the cover and at the left or right side of the footer region of each page.

© 2008-2018 Kodan Electronics Co., Ltd. All rights reserved.

No part of this publication may be reproduced, transmitted, translated in any form by any means without the written permission of Kodan Electronics Co., Ltd. The technical descriptions contained in this publication are subject to change without notice. Kodan assumes no responsibility for any errors, incidentals or consequential damages caused by misinterpretation of the descriptions contained in this publication.





## Important Notices

- The re-use and transcription of Operation Manual (hereafter called this manual) needs permission of our company. Our company prohibits the un-authorized re-use and transcription.
- If this manual is lost or damaged, consult our dealer or our company.
- The specification of our products and the content in this manual are subject to changed without notice.
- In the explanation of this manual, the content displayed on the menu of product may be different, depending on the situation. The keys and menus in the illustration may differ in physical font and shape. And some parts may be omitted.
- Our company is not liable for damage and trouble arising from misunderstanding of the content described in this manual.
- Our company is not liable for earthquake, lightning, fire for which our company is not responsible, action by third party, other accident, customer's unintended error/abuse and damage caused by the use under other abnormal condition.
- Our company is not liable for damage of accompaniment (change/loss of memorized content, loss of business profit, stop of business) arising from use or failure of our product.
- If the stored data is changed or lost, irrespective of any cause of trouble and damage, our company is not liable for it.
- Our company is not liable for any damage arising from malfunction caused by combination of such software and connected equipment that did not involve our company.







## For Your Safe Operation

### Symbol used in this Operation Manual

This manual uses the following symbols. Understand the meaning of each symbol and implement the maintenance and inspection.

Symbol	Meaning
 <b>Warning</b>	<b>Mark for warning</b> This symbol denotes that there is a risk of death or serious injury when not dealing with it correctly.
	<b>Mark for danger high voltage</b> This symbol denotes that there is a risk of death or serious injury caused by electric shock when not dealing with it correctly.
 <b>Caution</b>	<b>Mark for caution</b> This symbol denotes that there is a risk of slight injury or damage of device when not dealing with it correctly.
	<b>Mark for prohibition</b> This symbol denotes prohibition of the specified conduct. Description of the prohibition is displayed near the mark.
<b>IMPORTANT</b>	<b>Mark for important matters</b> This mark denotes that there is a possibility that data loss may interfere the operation or that the expected result may not be obtained when the radar is not dealt correctly.
	<b>Mark for reference</b> This mark shows the part to be referred to concerning this description.





**Caution Item on Equipment**

	<p><b>Caution on a high voltage inside.</b>                  A high voltage, which may risk your life, is used. This high voltage remains in the circuit after you have powered off switch. To prevent touching the high voltage circuit inadvertently, the protective cover is provided to the high voltage circuit and the high voltage caution label is affixed. Ensure to power off switch for your safety and discharge the electricity remaining in the capacitor before starting to check. An engineer authorized by our company should inspect and maintain the circuit.</p>
 <p><b>Warning</b></p>	<p><b>Be sure to switch off the power in the boat.</b>                  If the power switch is inadvertently powered on during work, you will be electrified. To prevent such accident from occurring, ensure to switch off the power in the boat and the power of equipment. Furthermore, it is safer to hang the caution tag with description of [Under Work] near the power switch of equipment.</p>
 <p><b>Warning</b></p>	<p><b>Caution on dust</b>                  Inhaling dust may cause A respiratory disease. When cleaning the inside of equipment, be careful not to inhale dust. Wearing a safety mask is recommended.</p>
 <p><b>Caution</b></p>	<p><b>Caution on location of equipment</b>                  Do not install the equipment where it is excessively damp and suffers from excessive water drops.</p>
 <p><b>Caution</b></p>	<p><b>Caution on static electricity</b>                  The static electricity may be generated from the carpet on the floor in the cabin or clothes made of synthetic fiber. The static electricity may destroy the electronic parts on the circuit board. Handle the circuit board, taking the suitable anti-static measures.</p>
	<p><b>Prohibited matter</b>                  Any Display and Scanner unit combination other than specified in the manual is prohibited and will void manufacturer's warranty.</p>



**Caution Item on Handling**

 <p><b>Caution</b></p>	<p><b>Caution on the rotating aerial</b></p> <p>The radar antenna may start to rotate without notice. Please stand clear from the antenna for your safety.</p>
---	--

 <p><b>Caution</b></p>	<p><b>Caution on electromagnetic disturbance</b></p> <p>The operating antenna &amp; scanner unit radiates high-energy electromagnetic wave. It may cause harmful effect for human body due to its continuous irradiation. As International regulation says, electromagnetic waves less than 100 watt/m<sup>2</sup> does not have a harmful effect on human bodies, but some kind of medical devices such as heart pacemakers are sensitive even under the low energy electromagnetic wave. Any personnel with such a device should keep away from the electromagnetic wave generating position at all times. Specified power density and distance from the radar (in accordance with the provision as specified in IEC 60945)</p> <table border="1" style="width: 100%; border-collapse: collapse;"> <thead> <tr> <th style="width: 15%;">Model</th> <th style="width: 45%;">Xmit power/Antenna length</th> <th style="width: 15%;">100W/m<sup>2</sup></th> <th style="width: 25%;">10W/m<sup>2</sup></th> </tr> </thead> <tbody> <tr> <td>MDC-921</td> <td>2kW/ 1.2 feet (Radome antenna)</td> <td>0.4 m</td> <td>1.27 m</td> </tr> <tr> <td>MDC-941</td> <td>4kW/ 2 feet (Radome antenna)</td> <td>0.8 m</td> <td>2.54 m</td> </tr> <tr> <td rowspan="2">MDC-940</td> <td>4kW/ 3 feet (Open antenna)</td> <td>0.9 m</td> <td>2.85 m</td> </tr> <tr> <td>4kW/ 4 feet (Open antenna)</td> <td>1.01 m</td> <td>3.2 m</td> </tr> </tbody> </table>	Model	Xmit power/Antenna length	100W/m <sup>2</sup>	10W/m <sup>2</sup>	MDC-921	2kW/ 1.2 feet (Radome antenna)	0.4 m	1.27 m	MDC-941	4kW/ 2 feet (Radome antenna)	0.8 m	2.54 m	MDC-940	4kW/ 3 feet (Open antenna)	0.9 m	2.85 m	4kW/ 4 feet (Open antenna)	1.01 m	3.2 m
Model	Xmit power/Antenna length	100W/m <sup>2</sup>	10W/m <sup>2</sup>																	
MDC-921	2kW/ 1.2 feet (Radome antenna)	0.4 m	1.27 m																	
MDC-941	4kW/ 2 feet (Radome antenna)	0.8 m	2.54 m																	
MDC-940	4kW/ 3 feet (Open antenna)	0.9 m	2.85 m																	
	4kW/ 4 feet (Open antenna)	1.01 m	3.2 m																	

 <b>Warning</b>	Do not disassemble or modify. It may lead to trouble, fire, smoking or electric shock. In case of trouble, contact our dealer or our company.
 <b>Warning</b>	In case of smoke or fire, switch off the power in the boat and the power of equipment. It may cause fire, electric shock or damage.
	Caution on the remaining high voltage. A high voltage may remain in the capacitor for several minutes after you have powered off. Before inspecting inside, wait at least 5 minutes after powering off or discharging the remaining electricity in an appropriate manner. Then, start the work.
 <b>Caution</b>	The information displayed in this unit is not provided directly for your navigation. For your navigation, be sure to see the specified material.
 <b>Caution</b>	Use the specified fuse. If un-specified fuse is used, it may cause a fire, smoke or damage.

**Caution on Display Unit**

 <b>Caution</b>	Do not push or scrub the surface of the display unit with a pointed tip of a hard matter (tool, tip of a pen, etc) Scars could be made.
 <b>Caution</b>	Do not press the surface of the display unit. Interference stripes or display abnormality could occur.

**Disposal of this radar**

This radar shall be disposed according to the municipal regulations or rules.



**Break in procedure of stored radar****Caution**

Following procedure is recommended for “Break In” of the stored radar.

Otherwise the radar sometimes exhibits unstable transmitting operation such as arcing at its initial operation after long period of storage and make the operation more difficult.

1. Extend preheat time as long as possible (preferably 20 to 30 minutes).
2. Set the pulse length to the shortest one and start the operation. When the operation in the shortest pulse is stable then go to operation in longer pulse and repeat the similar step until the operation reaches to the final pulse condition.

# Contents

Document Revision History .....	i	Delete of Heading Line.....	1-9
Important Notices .....	ii	1.11 Use of Crosshair Cursor.....	1-9
For Your Safe Operation.....	iii	1.12 Measuring the distance and	
Break in procedure of stored radar		bearing between two points .....	1-10
.....	vii	Measuring the distance and	
Contents .....	viii	bearing between two points .....	1-10
Introduction.....	xi	1.13 Camera Display.....	1-10
System Configuration .....	xii	How to connect a CCD	
Configuration of Equipment.....	xiii	camera .....	1-10
Chapter 1 Basic Operation.....	1-1	How to display the video of a	
1.1 How to read the radar screen.....	1-3	CCD camera .....	1-10
1.2 How to use the keys.....	1-4	Chapter 2 How to use the menu.....	2-1
1.3 Power On/Off.....	1-6	2.1 How to operate the menu.....	2-1
Power On .....	1-6	Display/Non-display of Menu .....	2-1
Power Off .....	1-6	Operation of Menu .....	2-1
Language Selection at Initial		2.2 FTC Adjustment .....	2-2
Start-up.....	1-6	2.3 Setting of Display Mode .....	2-2
1.4 Brilliance Adjustment.....	1-6	H UP (Head Up) .....	2-2
Brightness Adjustment of LCD ...	1-6	N UP (North Up) .....	2-3
Brightness Adjustment of		C UP (Course Up) .....	2-3
Panel .....	1-6	WPT UP (Waypoint Up) .....	2-3
1.5 Transmission .....	1-6	Relative Motion (RM) and True	
Start of Transmission.....	1-6	Motion (TM).....	2-3
Stop of Transmission.....	1-6	True Motion Reset.....	2-5
1.6 Switch-over of Range.....	1-7	2.4 Display Select .....	2-5
Change of Range .....	1-7	PPI Display.....	2-5
Change of Sub-screen Range....	1-7	PPI/PPI Display .....	2-5
1.7 Gain Adjustment .....	1-7	Note on PPI/PPI Display .....	2-6
Gain Adjustment.....	1-7	PPI/NAV Display .....	2-6
Adjustment of Sub-screen		Note on PPI/NAV Display .....	2-6
Gain.....	1-7	2.5 Setting of OFF CENTER .....	2-6
1.8 STC Adjustment .....	1-8	2.6 Setting of Enhance	
STC Adjustment .....	1-8	(Enlarged Target) .....	2-6
1.9 Use of [F1] and [F2] keys.....	1-8	2.7 Setting of Signal Process .....	2-6
How to use [F1] and [F2] keys ...	1-8	2.8 Setting of Pulse Width.....	2-7
1.10 Delete of Heading Line.....	1-9	2.9 Trailing.....	2-7

Relative Display (R) .....	2-7	Range Rings .....	3-1
True Display (T) .....	2-8	Range Unit .....	3-1
2.10 EBL .....	2-8	Speed Unit .....	3-1
2.11 VRM .....	2-8	Temperature Unit .....	3-1
2.12 Display Color .....	2-9	Depth Unit .....	3-1
2.13 Crosshair Cursor Shape .....	2-9	Position Display .....	3-1
2.14 PI (Parallel Index Line) .....	2-9	WPT Display .....	3-2
2.15 Bearing Mode .....	2-9	Rotation Speed .....	3-2
2.16 Vector .....	2-9	ALL PPI .....	3-2
2.17 Alarm .....	2-10	Guide .....	3-2
IN Mode .....	2-10	Buzzer .....	3-2
OUT Mode .....	2-10	Motor Speed .....	3-2
Setting of Alarm Range .....	2-10	N UP/S UP .....	3-2
2.18 Sleep .....	2-10	Crosshair Cursor Display .....	3-2
Operation during executing the		Radar Setting Display .....	3-2
sleep .....	2-11	Menu Operation .....	3-2
2.19 AIS .....	2-11	3.3 Setting of Adjustment Items .....	3-2
Setting of Symbol Display of		Bearing Setting .....	3-3
AIS .....	2-11	TX Delay Adjustment .....	3-3
Setting of Detailed Information of		MBS .....	3-3
Designated Symbol Display .....	2-11	STC Curve .....	3-4
Types and Meanings of AIS		Tune Select .....	3-5
Symbols .....	2-11	Automatic Tuning .....	3-5
2.20 ATA .....	2-12	Manual Tune Adjustment .....	3-5
Automatic Acquisition .....	2-12	Pulse Width .....	3-5
Manual Acquisition .....	2-13	Interference Rejection .....	3-6
Target Level .....	2-13	Echo Color Divide .....	3-6
Target Delete .....	2-13	Signal Select .....	3-6
Number of Acquisition .....	2-13	Field of Angle .....	3-6
Information Display .....	2-13	3.4 NMEA .....	3-7
Types and Meanings of ATA		KGC-1 Setting (Connection with	
Symbols .....	2-14	the KODEN GPS compass) .....	3-7
Chapter 3 How to use the system		3.5 Preset .....	3-7
menu .....	3-1	F1/F2 Key Set .....	3-7
3.1 Display of System Menu .....	3-1	Select Range .....	3-7
Display the System Menu .....	3-1	Echo Color Set .....	3-7
Return to the normal menu .....	3-1	Trail Color Set .....	3-7
3.2 Setting of Assist Items .....	3-1	Display Color Set .....	3-7
		Language Select .....	3-7

NAV Display Select .....	3-7	5.4	Adjustment after Installation.....	5-13
Camera Position Correction .....	3-7	5.5	Wiring .....	5-14
3.6 Maintenance.....	3-8		Cable connection to the Display	
Display Unit .....	3-8		unit.....	5-14
Antenna .....	3-8		Pin Assignment of Rear	
Panel Test.....	3-8		Connector.....	5-15
LCD Test.....	3-8		Connection of DC power	
Operation Hours Reset .....	3-8		cable.....	5-16
TX Hours Reset.....	3-8		Grounding .....	5-16
ALL Reset.....	3-8		Connection with the AIS	
System Program Renewal .....	3-8		Receiver .....	5-16
Chapter 4 Maintenance.....	4-1		Connection with the navigation	
4.1 Maintenance.....	4-1		equipment .....	5-17
Monthly Inspection .....	4-1		Connection of External Buzzer	
Yearly Inspection .....	4-2		and External Monitor .....	5-17
4.2 Fuse Replacement.....	4-3		Connection of CCD Camera ....	5-18
4.3 Consumables .....	4-3	5.6	List of Input/Output Sentence ..	5-18
4.4 Trouble Diagnosis .....	4-3		Input Sentence .....	5-18
Information required for			Output Sentence .....	5-18
requesting a repair .....	4-3	Chapter 6	Attached Table .....	6-1
Error Display .....	4-3	6.1	Menu Configuration.....	6-1
Self-diagnostic Function.....	4-4	6.2	Specifications .....	6-3
Inspection at Each Location .....	4-5	6.3	External View .....	6-5
Chapter 5 Equipment .....	5-1	Chapter 7	Principle of radar system .....	7-1
5.1 Antenna Installation.....	5-1	7.1	What is the radar system? .....	7-1
Determining the location of			Side lobe .....	7-1
the installation .....	5-1		Beam width.....	7-1
How to shift the antenna from an		7.2	Characteristics of radar radio	
obstacle .....	5-2		wave .....	7-2
Installation of Antenna.....	5-3		Target with less reflection.....	7-2
Installation of Radome Antenna .	5-3		Radar shadow .....	7-2
Setting of Open Antenna .....	5-4		False image.....	7-2
Installation of Antenna.....	5-5	7.3	Radar interference .....	7-4
Cable Connection.....	5-6			
5.2 Mutual Connection Diagram.....	5-10			
5.3 Display Unit Installation.....	5-11			
Desktop Installation.....	5-11			
Flush-mount Installation .....	5-12			

## Introduction

Thank for your purchase of KODEN color LCD radar MDC-900 Series.

The quality and endurance of a unit is well considered. For the best performance, read this Operation Manual and operate a unit correctly and safely.

The main features of this unit are as follows.

- The high performance radar equipped with 8.4 inch display can be used for professional use.
- In the true trail function, as moving targets such as other ships are displayed being tailed and stationary targets such as land are displayed being fixed, the moving targets and fixed targets can be easily discriminated.
- Two screen images of different ranges can be displayed. If you set a near distance screen and a far distance, you can navigate properly and grasp a situation.
- The automatic tracking function (ATA) is provided. The maximum 50 targets can be tracked. The current motion of other ships can be grasped in a vector and numeral so that it helps your ship to navigate safely. (Optional)
- By connecting the AIS receiver, the gathered information such as name, heading and speed of a ship can be displayed. (Optional interface)
- With the adoption of a specific filter (AR coat), an image can be seen clearly, refusing sunshine. The countermeasures against the reflection on the LCD screen and dew are provided.
- The RGB output for an external monitor is provided as standard equipment. The use of the external monitor enables you to observe easily the radar screen at a location which is remote from a main unit. (External monitor: Prepared by a customer)
- A video from a CCD camera can be displayed. The inside of a ship can be observed by a camera installed at the engine room helps your ship navigate safely. (CCD camera: Prepared by a customer)
- With the adoption of the GAIN/STC rotary knob, the operability is enhanced.
- When flush-mounted, a unit can be installed or removed from the front of the unit.

# System Configuration

## Connection Diagram

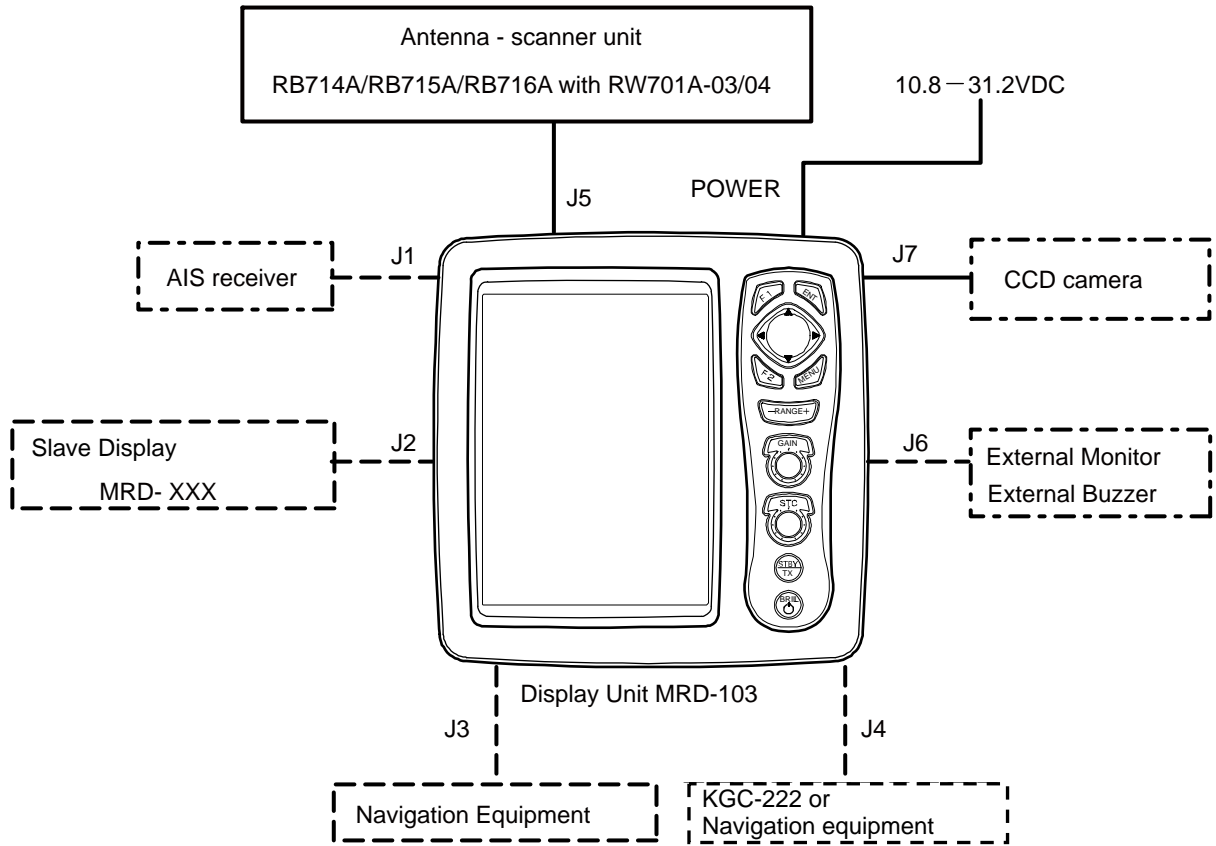





※ Be sure to connect the GPS compass to J4.

- : Standard product
- - - - - : Optional product
- · - · - : Product prepared by a user

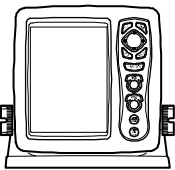
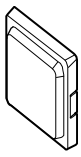
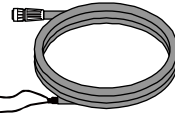
## Configuration of Equipment

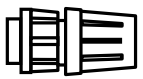
### Standard Equipment Configuration List

No.	Name of item	Type	Remarks	Weight/ Length	Quantity
1	Display unit 	MRD-103	With mounting bracket and knobs	3.7kg	1
2	Hard cover 	E57MB11060		0.25kg	1
3	DC power cable 	CW-265-2M	3-pin water resistant connector and one end plain	2m	1
4	Fuse 	F-1065-8A Cylinder (ø6.4x30)	Normal fusion type for main power		1
5	Connector 	BD-06BFFA-LL6001	6-pin water resistant connector		1
6	CCD camera cable 	CW-405-0.3M		0.3m	1
7	Antenna-scanner unit	See next page.	With cable		1
8	Operation Manual		English		1
9	Quick Reference		English		1

**Types of Antenna-scanner unit**

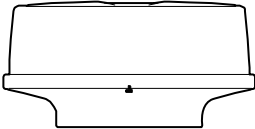
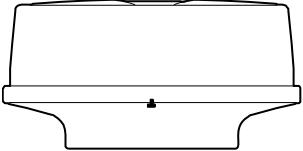
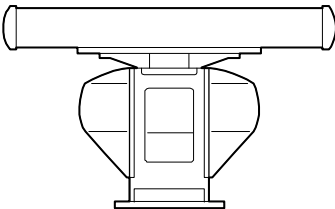
No.	Type	Transmitting Power	Shape	Remarks	Weight/Length
1	RB714A 	2kW	Radome	Interconnecting cable, 10m*, 242J160680A-10M	6kg / 1.2ft
2	RB715A 	4kW	Radome	Interconnecting cable, 10m*, 242J158055A-10M	10kg / 2ft
3	RB716A with RW701A-03/04 	4kW	Open	Interconnecting cable, 10m*, 242J159098A-10M	21kg / 3ft
					22kg / 4ft

\* Cables of 15m, 20m and 30m are available. (Optional)

**Optional List**

No.	Item Name	Type	Remarks	Cable Length
1	GPS compass	KGC-222	GPS/Heading measuring	
2	AIS interface board	AIS-110	100 targets	
3	Cable for AIS receiver	CW-376-5M	With 6-pin waterproof connector and one end plain.	5m
4	ATA board	MRE-340		
5	Cables for external monitor/external buzzer	CW-576-0.5M	10-pin water resistant connector and D-SUB connector (female) + Alarm out cable	0.5m
6	Cable for slave display	CW-561-10M	With 12-pin water resistant connectors at both ends.	10m
7	Power rectifier	PS-010	With 2 pieces of 5A fuse	
8	AC power cable	VV-2D8-3M	Both ends plain.	3m
9	Cable for navigation cable	CW-373-5M	6-pin water resistant connectors at both ends	5m
		CW-376-5M	With 6-pin waterproof connector and one end plain.	5m



- This page intentionally left blank.-

# Chapter 1 Basic Operation

The basic operation of this unit is as follows. For detailed explanation, refer to each item in this manual.

**1.** Press the [BRILL] to turn on the power.

1.3 Power On/Off

**2.** When [ST'BY] appears, press the [STBY/TX] key to start the transmission.

1.5 Transmission

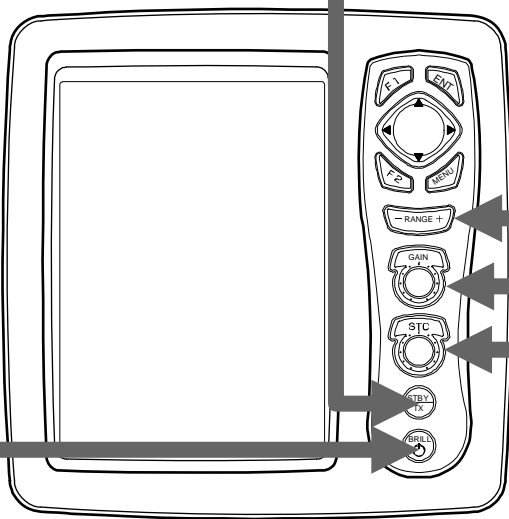

**5.** Rotate the [STC] knob to adjust the sea surface reflection suppression effect. The suppression effect becomes strong when rotating clockwise the knob and becomes weak when rotating counterclockwise the knob.

- This function reduces the gain at a near distance. If you turn clockwise the knob too much, desired objects may disappear. Adjust properly to meet the weather condition.

Example of STC adjustment :

✕ : The suppression is too weak.

The reflection from sea surface is displayed.

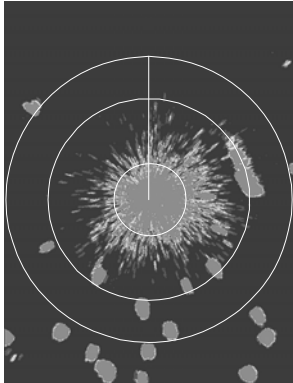

○ : Optimum suppression.

The desired objects are displayed.

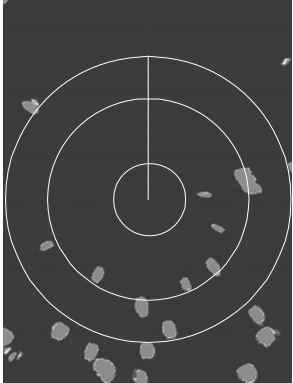

✕ : The suppression is too strong.

Some objects are not displayed.

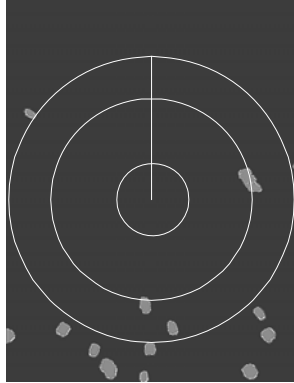

1.8 STC adjustment

**3.** Change the observation range with the [- RANGE +] key.

When pressing the [+] key, the observation range expands.  
When pressing the [-] key, the enlarged surrounding around own ship can be observed.  
To make it easier to observe the range you desire, change the range.

Example of display :

Long range : Far distance

Middle range : Middle distance

Short range : Near distance

Objects at far distance can be covered.

Objects near own ship can be easily confirmed.

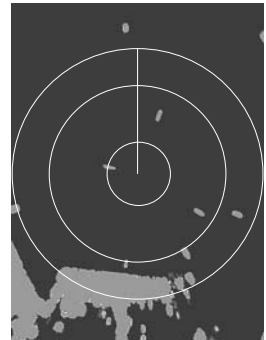
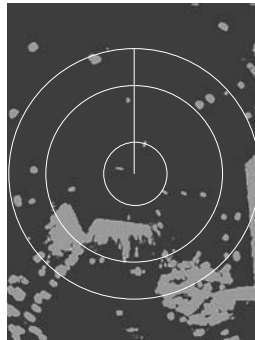
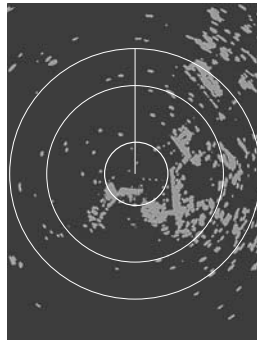

 1.6 Switch-over of range

**4.** Adjust the gain by rotating the [GAIN] knob.

The gain becomes high when rotating clockwise the knob and becomes low when rotating counterclockwise the knob.

When the observation range is narrow or targets are crowded, reduce the gain so that targets can be easily seen.

When the observation range is wide, if the gain is increased, it is effective.

But, due to noise increase, small targets become hard to be seen.

Example of gain adjustment:

× : Too high gain  
Noise is also displayed.

○ : Optimum gain  
Desired targets are displayed.

× : Too low gain  
Some targets are not displayed.

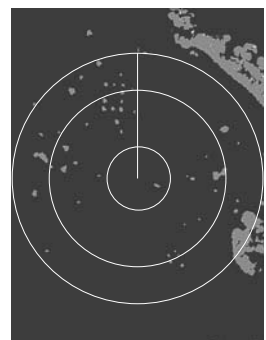
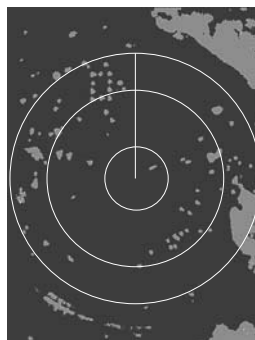
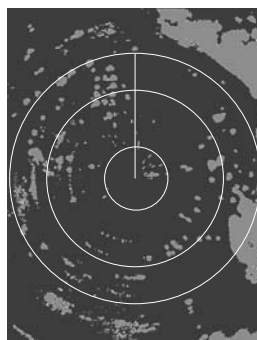

 1.7 Gain adjustment

# 1.1 How to read the radar screen

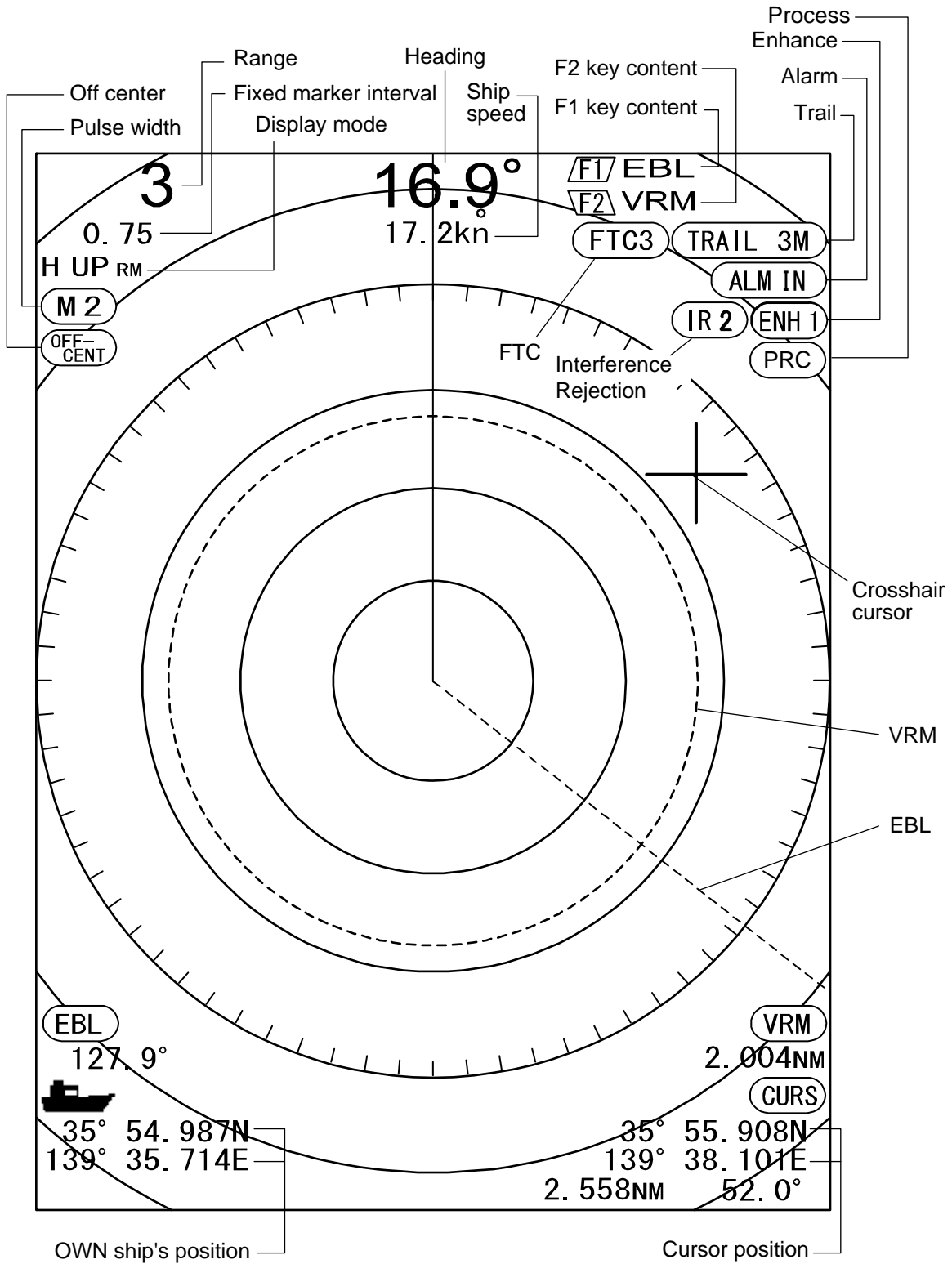

## 1.2 How to use the keys

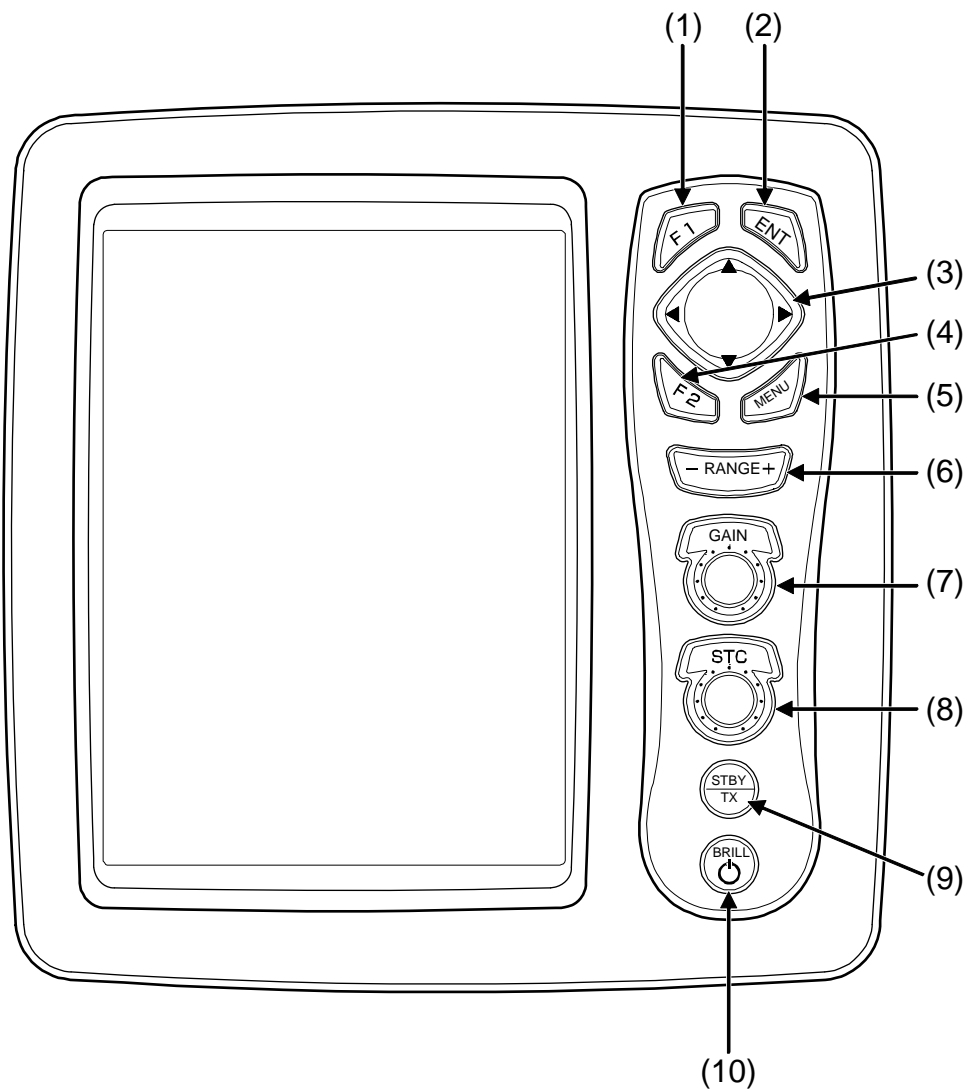

Various adjustment items can be set by operating each key.

The menu displayed by pressing the [MENU] key closes when pressing the [MENU] key again.

Number	Key name	Explanation
(1)	[F1]*	Recalls directly the preset menu item.
(2)	[ENT] *	Press: measures bearing of distance between two points. Continuously pressing: Deletes the heading line. The crosshair cursor moves to the own ship's position. The value in the menu is set. (Some of functions)
(3)	CURSOR [▲], [▼] [◀], [▶]	Selects the menu item. Changes the content of set value. Moves the crosshair cursor.
(4)	[F2] *	Recall directly the preset menu item.
(5)	[MENU] *	Opens or closes the menu.
(6)	[- RANGE+]	Changes the range setup.
(7)	[GAIN] *	Rotate: Changes the gain. Push: Changes the gain adjustment of sub-screen (lower screen of PPI/PPI) and the range. In the PPI or PPI/NAV display, recall directly the preset menu item.
(8)	[STC]	Rotate: Changes the STC. Push: Display the video of a CCD camera. When the video of a CCD camera is displayed, if you press it, the size of video changes. When not connecting CCD camera, recall directly the preset menu item.
(9)	[STBY/TX]	Starts or stops the transmission.
(10)	[BRILL]*	Push: Adjusts the brilliance and the brightness of the panel. Continuously pressing: Turns on or off the power.

\* In case of pressing it during the CCD camera on, the display of the CCD camera becomes off.

When the alarm is functioning, the alarm stops by operating any key.

## 1.3 Power On/Off

The [BRILL] key is used for both the power on/off and the change of brilliance of the LCD & panel.

### Power On

- 1 Press the [BRILL] key to turn on the power. The start-up menu is displayed. During the display of start-up menu, the memory is automatically checked. If the check result is correct, the radar image appears, and start count down time for magnetron preheat.

### Power Off

- 1 When turning off the power, keep pressing the [BRILL] key for 3 seconds.

#### Caution



Re-entry of power shall be performed after having passed for longer than 3 seconds after power-off.

### Language Selection at Initial Start-up

When turning on the power for the first time after [ALL RESET], the [LANGUAGE] menu appears.

LANGUAGE
ENGLISH
日本語

- 1 Select the language with [▲] and [▼] keys. During display of [LANGUAGE] menu, pressing the [◀] key will return to the initial setup menu. Pressing the [▶] key will redisplay the [LANGUAGE] menu.

PRESET	LANGUAGE	ENGLISH

- 2 Press the [MENU] key to set the language.

## 1.4 Brilliance Adjustment

### Brightness Adjustment of LCD

The brilliance of menu can be adjusted to make it easier to see.

Setup: (1 to 10) (Initial value: 10)

- 1 Press the [BRILL] key briefly.

- 2 Press the [▲] and [▼] keys. "1" is darkest. "10" is brightest.

LCD BRILL
10

- 3 Press the [MENU] key or [ENT] key to close the menu.

### Brightness Adjustment of Panel

The panel brightness can be adjusted,

Setup: (1 to 10) (Initial value: 10)

- 1 Press the [BRILL] key briefly. When [LCD BRILL] appears, press the [BRILL] key again.
- 2 Select the level with the [▲] and [▼] keys. "1" is darkest. "10" is brightest.

PANEL BRILL
10

- 3 Press the [MENU] key or [ENT] key to close the menu.

## 1.5 Transmission

### Start of Transmission

After turning on the power, remaining time of pre-heat is displayed in the center of the screen. After 120 seconds, ST'BY appears in the center of the screen and the unit becomes "STBY" state. On the "STBY" state, when the [STBY/TX] key is pressed, the unit starts the transmission.

### Stop of Transmission

On the "TX" state, when the [STBY/TX] key is pressed, the unit stops the transmission and returns to the "STBY" mode.

## 1.6 Switch-over of Range

The observation range can be changed.

### Change of Range

- 1 Press the [- RANGE +] key.  
When pressing the [+] key, an image shrinks but the observation range expands.  
When pressing the [-] key, the observation range becomes narrow but the enlarged surroundings around own ship can be seen.  
  
The value of the range is displayed at the upper left side of the screen.

### Change of Sub-screen Range

Change the range of the lower screen (sub-screen) of the PPI/PPI menu.

☞ For the PPI/PPI screen, refer to 2.4 Display Select.

- 1 Press the [GAIN] knob.  
When the [SUB-SCREEN RANGE] appears, press the [GAIN] knob again.
- 2 Change the range of the sub-screen range with the [▲] and [▼] keys.



- 3 Press the [MENU] key or [ENT] key to close the menu.

## 1.7 Gain Adjustment

Adjust the gain according to the distance range and reflection from the sea surface/rain/snow to observe an image easily.

### Gain Adjustment

- 1 When rotating clockwise the [GAIN] knob, the gain increases.  
When rotating counterclockwise the [GAIN] knob, the gain decreases.
- When the short distance or targets are crowded, if the gain is reduced, the image can be easily seen.
  - When the long distance, if the gain is increased, it is effective but due to increase of noise, the image becomes hard to be seen.

Result picture after adjustment by [GAIN] knob

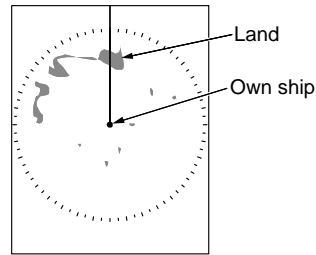

<Picture of too low gain>

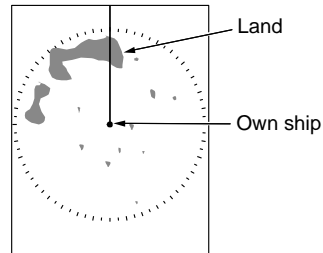

<Picture of adjusted gain>

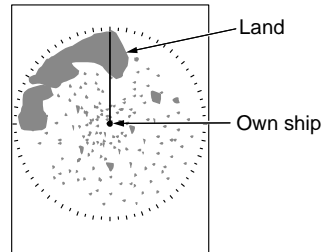

<Picture of too much gain>

In the PPI/PPI menu, the gain of the upper screen (main screen) changes when the [GAIN] knob is adjusted.

### Adjustment of Sub-screen Gain

Adjust the lower screen (sub-screen) in the PPI/PPI menu.

☞ For the PPI/PPI screen, refer to 2.4 Display Select.

- 1 Press the [GAIN] knob.  
When the [SUB-SCREEN RANGE] appears, press the [GAIN] knob again.
- 2 Adjust the sub-screen gain again with the [▲] and [▼] keys.  
The gain increases when increasing the numeral and decreases when decreasing the numeral.

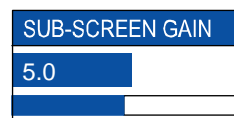

- 3 Press the [MENU] key or [ENT] key to close the menu.



## 1.8 STC Adjustment

In the short distance menu, even if waves are low and the sea surface is calm, an echo reflected from the sea surface appears in the image.

When waves become high, the sea surface reflected echo covers around the center of the image and make it harder to see targets.

Adjust the STC to suppress the reflection from the sea surface so that the image becomes visible easily.

### STC Adjustment

- 1 When rotating clockwise the [STC] knob, the reflection suppressing effect becomes stronger.
- When not influenced by waves, rotate fully counterclockwise the [STC] knob.
  - This function reduces the gain at short distance. If rotating clockwise the [STC] knob too much, desired targets disappear.

Picture after adjustment with [STC] knob

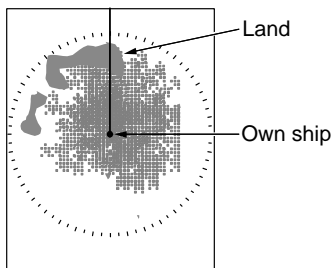

<Picture of too low STC>

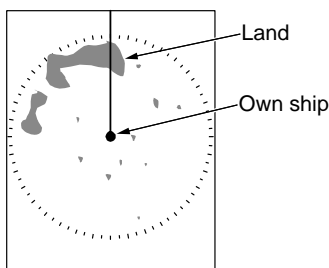

<Picture of adjusted STC>

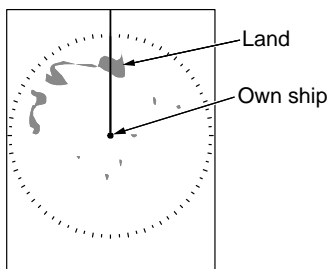

<Picture of too much STC>

In the PPI/PPI menu, when rotating the [STC] knob, the STC functions effective in both displays.

## 1.9 Use of [F1] and [F2] keys

The following functions can be assigned to the [F1] and [F2] keys.

- [FTC]
- [MODE]
- [DISPLAY SELECT]
- [OFF CENTER]
- [ENHANCE]
- [TRAIL TIME]
- [EBL]
- [VRM]
- [COLOR]
- [PI]
- [ALARM MODE]
- [MAN ACQ]
- [DELETE]
- [POB]
- [TARGET]
- [OTHER SHIP]
- [PULSE]
- [PROCESS]

☞ Refer to the F1/F2 keys set in 3.5 Preset.

The assigned function is displayed at the upper right side of the screen.

### How to use [F1] and [F2] keys

When pressing the [F1] / [F2] key, the assigned function works.

Function	Operation
FTC	When pressing the [F1] / [F2] key, the setup of FTC changes.
Mode	When pressing the [F1] / [F2] key, the display mode changes.
Display Select	When pressing the [F1] / [F2] key, the display changes.
Off Center	After pressing the [F1] / [F2] key, if [▲] or [▼] key is pressed, the ON/OFF setup of the OFF CENTER changes. After pressing the [▶] key with ON selected and moving the crosshair cursor, if the [ENT] key is pressed, the position of crosshair cursor is set as a position of own ship.
Enhance	When pressing the [F1] / [F2] key, the setup of ENHANCE changes.

Trail Time	When pressing the [F1] / [F2] key, the trail time changes.
EBL	The On/Off display of EBL is toggled by pressing the [F1] / [F2] key. Operate the EBL during display with the [◀] and [▶] keys.
VRM	The On/Off display of VRM is toggled by pressing the [F1] / [F2] key. Operate the VRM during display with the [▲] and [▼] keys.
Color	When pressing the [F1] / [F2] key, the display color changes.
PI (Parallel Index Line)	After pressing the [F1] / [F2] key, the display of parallel cursor changes to the one side/both sides/OFF. After pressing the [▶] key to the one side/both sides, change the interval with the [▲] / [▼] keys and then the bearing with [◀] / [▶] keys.
Alarm Mode	After pressing the [F1] / [F2] key, if the [▲] or [▼] key is pressed, the alarm mode changes to the IN/OUT/OFF. When selecting the In/Out, if the [▶] key is pressed, the mode enters in the alarm range set state.
Acquire*	When pressing the [F1] / [F2] key, a target aligned with the crosshair cursor is acquired.
Delete*	In case of selecting [NUMBER] in the menu, if the [F1] / [F2] key is pressed, the numeral selection menu appears. Select the number of the desired capture to be released with [▲] / [▼] keys and press the [ENT] key to set it. In case of selecting [CURSOR] in the menu, if the [F1] / [F2] key is pressed, the capture of a target aligned with the crosshair cursor is released.
POB***	The position of own ship at the moment when the [F1] / [F2] key is pressed is stored as a POB position. In the state that the POB position is stored, if the [▲] or [▼] key is pressed after pressing the [F1] / [F2] key, the setup of renewal/release of the POB position can be changed. The renewal or release of the POB position can be performed with the [ENT] key.
Target***	The position of crosshair cursor at the moment when pressing the [F1] / [F2] key is outputted to the external terminal with the TLL sentence.

Other Ship**	When pressing the [F1] / [F2] key, the information of a target aligned with the crosshair cursor is displayed in the window.
Pulse	When pressing the [F1] / [F2] key, the pulse width changes.
Process	When pressing the [F1] / [F2] key, the process changes.

\* The ATA board (optional) is required.  
 \*\* The AIS interface board / cable (optional) or ATA board (optional) is required.  
 \*\*\* Inputting the bearing, the latitude and longitude data is required.

### 1.10 Delete of Heading Line

When a heading line overlaps over targets and it is hard to see targets, the heading line can be deleted.

#### Delete of Heading Line

- 1 When keep pressing the [ENT] key, the heading line disappears. While pressing the [ENT] key, heading line can be deleted.

**Caution**  For safety, it is not allowed that the heading line remains deleted.

- 2 When releasing the [ENT] key, the heading line appears again. At this moment, the crosshair cursor moves to the own ship's position.

### 1.11 Use of Crosshair Cursor

The crosshair cursor can move freely on the radar screen. According to moving of the cursor, the cursor position, distance and bearing from own ship are displayed.

- 1 Press any of [▲], [▼], [◀] and [▶]. The crosshair cursor moves and the cursor information is displayed.

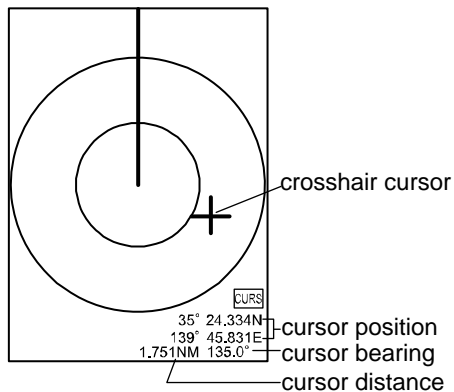

## 1.12 Measuring the distance and bearing between two points

The distance and bearing between two points, you desire, can be measured, using the crosshair cursor.

### Measuring the distance and bearing between two points

- 1 Move the crosshair cursor to one point desired with the [▲], [▼], [◀] and [▶] keys.
- 2 Press the [ENT] key to set it as an origin.
- 3 When moving the crosshair cursor with the [▲], [▼], [◀] and [▶] keys, the distance and bearing from the origin to the position of the crosshair cursor are displayed.
- 4 When pressing the [MENU] key, the 2-point calculation is finished.

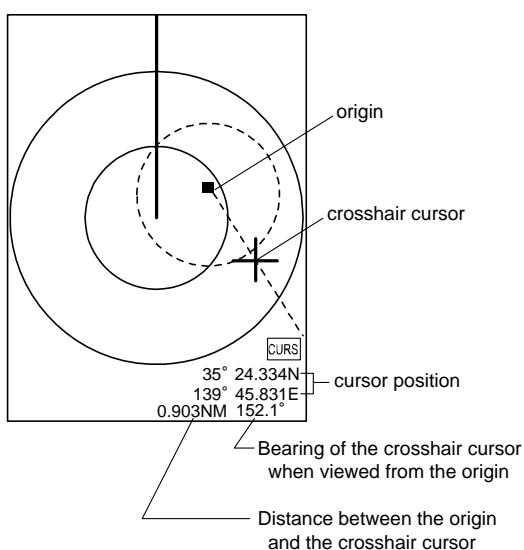

## 1.13 Camera Display

The video of a CCD camera can be displayed on the radar screen. (CCD camera: Prepared by a customer)

### How to connect a CCD camera

- 1 Connect CW-405-0.3M cable (optional cable) to the J7 in the rear connectors.
- 2 Connect a commercially available CCD camera to the cable.

### How to display the video of a CCD camera

- 1 Press the [STC] knob.  
The video of a CCD camera appears.  
A split-screen display and a full screen display are toggled by pressing the [STC] knob.
- 2 When pressing the [▲] or [▼] key in the state that a video of the CCD camera is displayed, the display position of the video of the camera video can be corrected.
- 3 When displaying the video of the CCD camera, if a key other than the [STBY/TX] [▲] and [▼] keys is pressed, the video of the CCD camera disappears.

Caution



When displaying the video of a CCD camera, the display area of the radar image is narrowed.  
When set to [Full Screen Display], the radar image is completely concealed.  
When displaying the video of a CCD camera, pay attention to the display area.

Caution



When installing a CCD camera, orient it correctly. When correctly installed, the 90 degree-shifted video of a CCD camera is displayed. Install a CCD camera in a correct orientation so that the video in a correct direction is displayed.

## Chapter 2 How to use the menu

### 2.1 How to operate the menu

#### Display/Non-display of Menu

- 1 Press the [MENU] key.  
The displays of the menu and the explanation of operation are displayed.

ECHO	Cursor	Setting item column
TRAILS	FTC	OFF
DISPLAY	MODE	H UP RM
ALARM	DISPLAY SELECT	PPI
AIS	OFF CENTER	OFF
ATA	ENHANCE	OFF
NEXT	PROCESS	OFF
	PULSE	RESO-P PRL

Menu column

When [Operation Guide] is set to ON, the explanation of operation appears.  
 See 3.2 Setting of Assist Items.

GUIDE	
-------	--

- 2 Press the [MENU] key, the display of the menu and the explanation of operation close.

#### Operation of Menu

- 1 When the menu is displayed, select a menu name with the [▲] and [▼] keys.  
According to the selected menu, contents in the setup items at the right side change.

ECHO	TRAIL MODE	OFF
TRAILS	TRAIL TIME	3MIN
DISPLAY	TRAIL SHAPE	STANDARD
ALARM	TRAIL LEVEL	7
AIS		
ATA		
NEXT		

- 2 Press the [▶] key.

- 3 Select an item you desire to change with the [▲] and [▼] keys.

ECHO	TRAIL MODE	REL
TRAILS	TRAIL TIME	3MIN
DISPLAY	TRAIL SHAPE	STANDARD
ALARM	TRAIL LEVEL	7
AIS		
ATA		
NEXT		

- 4 Press the [▶] key.  
According to the selected item, the setup menu appears.

TRAIL MODE
REL
TRUE

FIELD OF ANGLE
5.0

PI NUMBER
7
1 ~ 7

- 5 Change contents of setup with the [▲] and [▼] keys.
- 6 Press the [◀] key. Then, the cursor returns to the setup item column.
- 7 To select another menu name, press the [◀] key.  
The cursor returns to the menu column.
- 8 Press the [MENU] key to close the menu.



**Caution**

- Unless the AIS interface is equipped, you cannot operate the AIS menu.
- Unless the ATA interface is equipped, you cannot operate the ATA menu.

## 2.2 FTC Adjustment

When raining or snowing, due to reflection from rain or snow, an object is hard to be seen. By increasing the set value of FTC, the contour of an object, which was concealed by an image of rain or snow, appears. But, you may miss a small object. (Normally, set the FTC to OFF.)

Setup: OFF, 1 to 8 (Initial value: OFF)

Result picture after adjustment by FTC

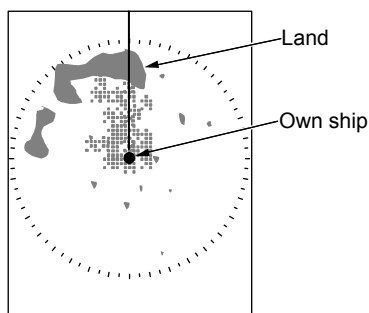

<Picture with rain clutter>

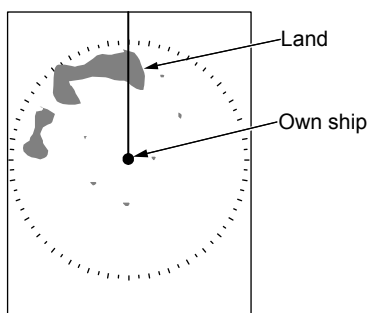

<Picture with rain reflex suppressed>

- 1 Press the [MENU] key.
- 2 Select [ECHO] → [FTC].
- 3 Change the setup of [FTC] with the [▲] and [▼] keys.



- 4 Press the [MENU] key to close the menu.

## 2.3 Setting of Display Mode

In the display mode, the bearing and the target motion are displayed in combination.

Setup: H UP<sub>RM</sub>, N UP<sub>RM</sub>, N UP<sub>TM</sub>, C UP<sub>RM</sub>, C UP<sub>TM</sub>, WPT UP<sub>RM</sub> (Initial value: H UP<sub>RM</sub>)

- 1 Press the [MENU] key.
- 2 Select [ECHO] → [MODE].
- 3 Change the setting of [MODE] with the [▲] and [▼] keys.
- 4 Press the [MENU] key to close the menu.

Four bearing displays of [H UP], [N UP], [C UP] and [WPT UP] are provided. [NUP] and [SUP] can be swapped.

☞ Refer to [N UP/S UP] in 3.2 Setting of Assist Items.

Two types of display method “RM” and “TM” are provided for the motion display.

- Entering the bearing data for C UP, N UP “RM” is required.
- Entering the bearing, speed and latitude/longitude data for C UP, N UP “TM” is required.
- Entering the WPT data for WPT UP is required.

Your ship heading is assumed 45° in the following description of each mode.

### H UP (Head Up)

The H UP is the display mode to orient the heading to the top of the screen.

In this mode, the heading is used as a reference and the screen image, which is similar to the visibility when navigating your ship, can be seen. Therefore, this mode is suitable for watching targets.

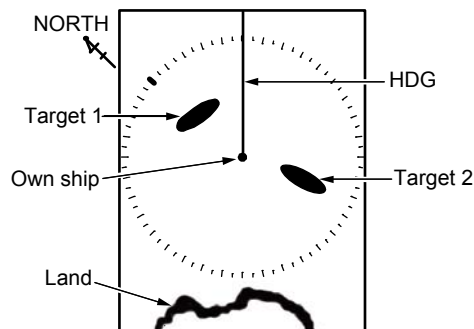

### N UP (North Up)

The N UP is the display mode to orient the true north to the top of the screen. Due to the true north oriented display, the screen image can be easily compared with a chart with a north oriented representation.

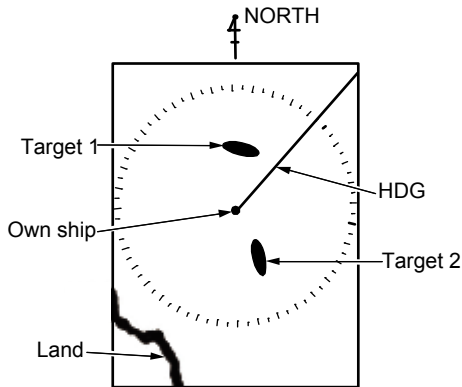

When selecting the S UP (South Up), the true south is oriented to the top of the screen.

### C UP (Course Up)

The C UP is the display mode in which the heading becomes the set course instantly when [C UP] is selected and the set course is oriented to the top of the screen.

When navigating your ship along the planned course, use this mode. If your ship is off the planned course, it visually shows the deviation from the planned course.

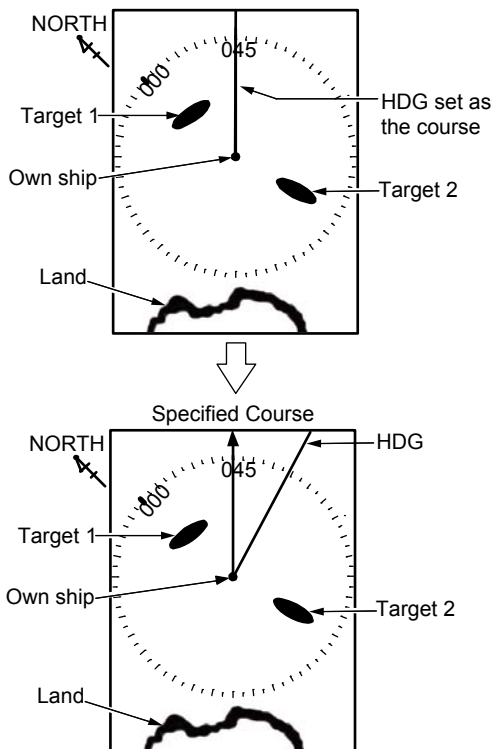

### WPT UP (Waypoint Up)

The WPT is the display mode to always orient the WPT to the top of the screen. When this mode is used in combination with the course up function of the plotter, the understandable image is available.

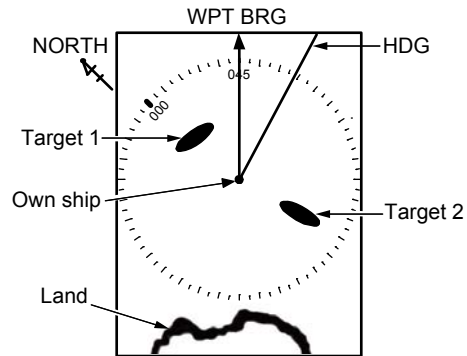

### Relative Motion (RM) and True Motion (TM)

The relative (RM) motion mode indicates motions of surrounding targets while fixing your ship's position at the center of the display. As the own ship's position is placed at the center of the display, the fixed targets such as the land move on the screen when the ship navigates.

The true (TM) motion indicates the motion of targets with respect to the specified bearing. Fixed targets, which do not move in any directions, stay on the screen, and all moving targets move on the screen.

**Caution** No true motion [TM] is provided for [H UP] mode as the constantly moving heading is used as a reference. The true motion [TM] is also not provided for [WPT UP] which uses the specified course as a reference.

**Caution** In [TM] mode, entering the data of the bearing, speed and latitude/longitude is required.

**Relative motion (RM):** The own ship is fixed and other surrounding targets move on the screen. This is useful when monitoring the surrounding situation based on your own ship's position.

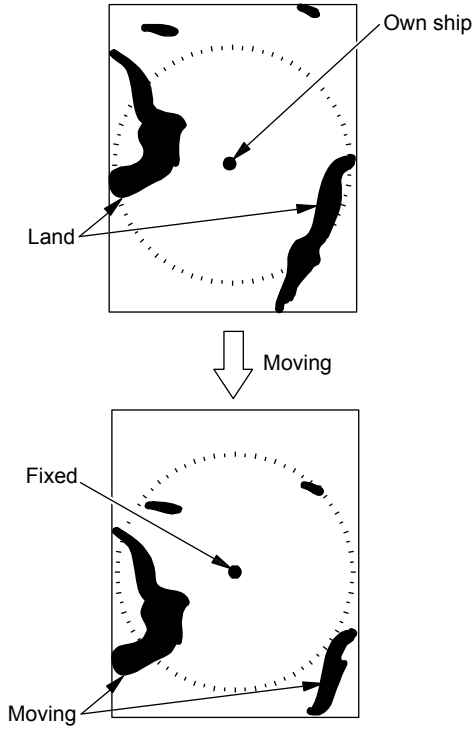

**True motion (TM):** Your ship moves according to its speed and tidal current on the screen. Stationary targets are fixed on the screen. It is useful when monitoring your ship's position with respect to the fixed targets such as land.

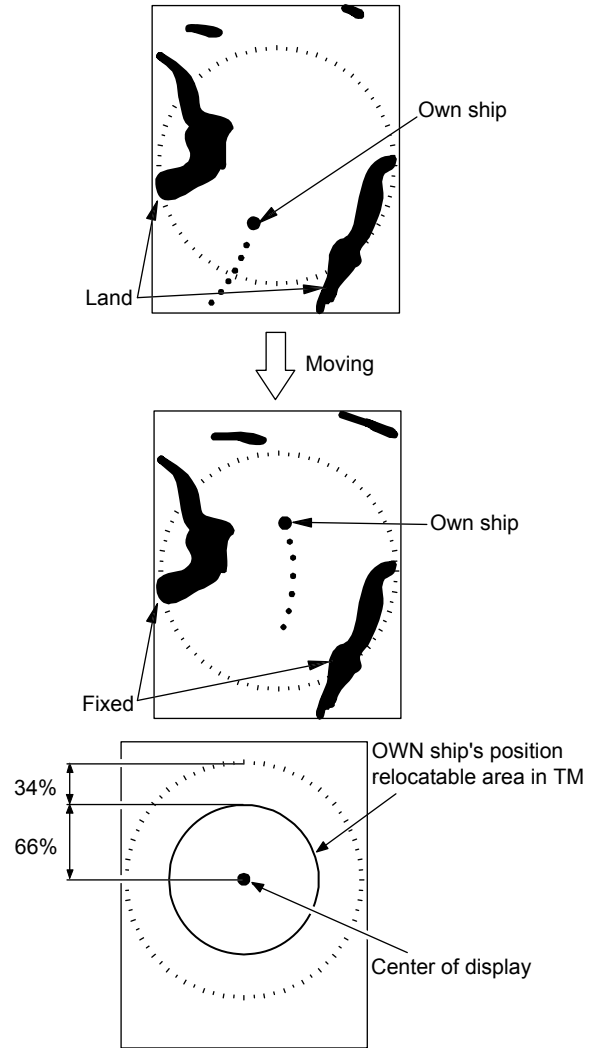

### True Motion Reset

When your ship exits from movable range of your ship's position, it moves to the opposite side within the range.

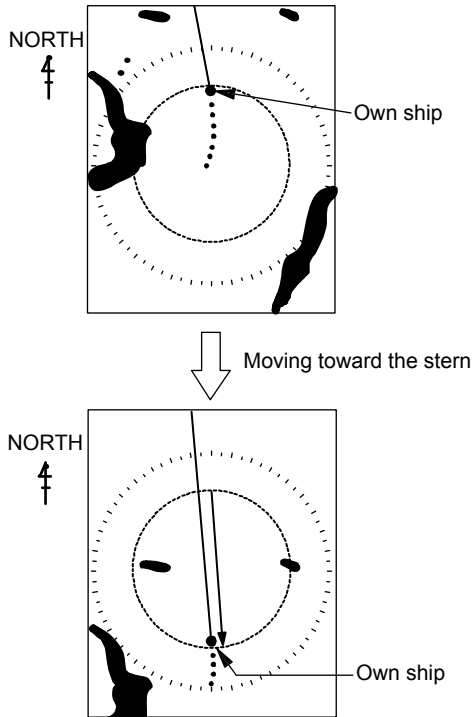

## 2.4 Display Select

The display selection designates the combination of the radar image to be displayed.

Setup: PPI, PPI/PPI, PPI/NAV (Initial value: PPI)

- 1 Press the [MENU] key
- 2 Select [ECHO] → [DISPLAY SELECT].
- 3 Change the setting of [DISPLAY SELECT] with the [▲] and [▼] keys.

DISPLAY SELECT
PPI
PPI / PPI
PPI / NAV

- 4 Press the [MENU] key to close the menu.

### PPI Display

The radar screen is displayed on the entire display.

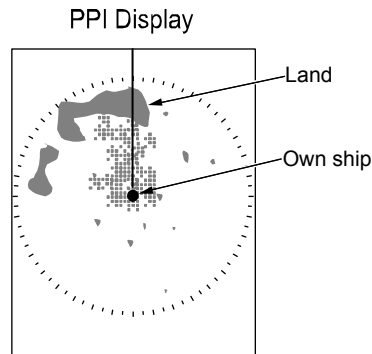

### PPI/PPI Display

Two radar images are displayed in the upper (main screen) and lower (sub-screen) halves of the screen. The screen is switched every two rotation of the antenna.

The images of two different ranges can be displayed.

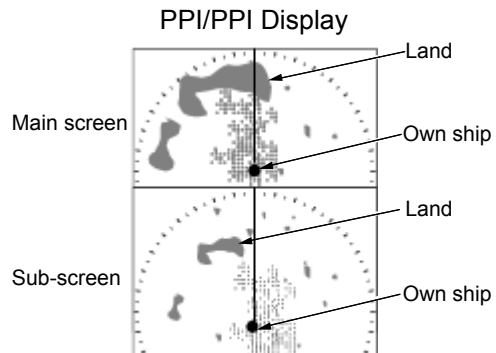

The range of the upper display (main screen) can be changed with the [- RANGE +] key. The gain of the upper display (main screen) can be adjusted by rotating the [GAIN] knob. The range of the lower display (sub-screen) can be changed with the [▲] and [▼] keys after displaying [SUB-SCREEN RANGE] by pressing the [GAIN] knob. The gain of the lower display (sub-screen) can be adjusted with the [▲] and [▼] keys after displaying [SUB-SCREEN GAIN] by pressing the [GAIN] knob. Other setting items are used in common in the main screen and sub-screen.



### Note on PPI/PPI Display

In the PPI/PPI display, to avoid risk, the following functions do not work.

- TM (True Motion)
- Off center
- Trailing
- ATA (Optional)

The EBL, VRM and PI (parallel cursor) can be displayed only in the main screen.

### PPI/NAV Display

The radar image is displayed in the upper half of the screen and the navigation data is displayed in the lower half of the screen.

The content of the navigation data display can be selected.

 For the NAV Display Select, refer to [NAV Display Select] in 3.5 Preset.

### Note on PPI/NAV Display

In the PPI/NAV display, to avoid risk, the following functions do not work.

- TM (True Motion)
- Off Center

## 2.5 Setting of OFF CENTER

When viewing widely in the heading, use this function.

Setup: OFF, ON (Initial value: OFF)

- 1 Press the [MENU] key
- 2 Select [ECHO] → [OFF CENTER].
- 3 Change the setting of [OFF CENTER] to [ON] with the [▲] and [▼] keys.  
It moves to the off center position where the own ship point is stored



- 4 Press the [▶] key.
- 5 Move the crosshair cursor to the point you desire to move your ship with the [▲], [▼], [◀] [▶] keys.
- 6 Press the [ENT] key.  
Own ship's position moves to the position of the crosshair cursor.

- 7 Press the [MENU] key to close the menu.

- The movable range is limited.  
(See the movable range shown below.)

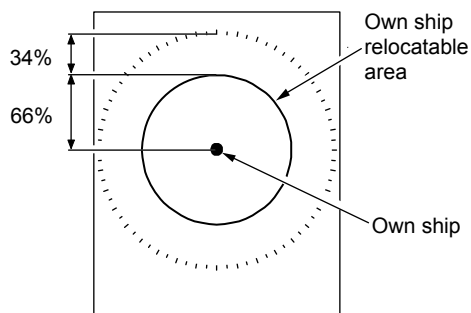

- When [PPI/PPI] or [PPI/NAV] is selected in [DISPLAY SELECT], the off-center cannot be executed.

## 2.6 Setting of Enhance (Enlarged Target)

If a target is too small to see, the target can be enlarged to make it easier to see it.

Setup: OFF, 1, 2 (Initial value: OFF)

- 1 Press the [MENU] key
- 2 Select [ECHO] → [ENHANCE].
- 3 Change the setting of [ENHANCE] with the [▲] and [▼] keys.  
The greater the numeral is, the larger the target is enlarged.
- 4 Press the [MENU] key to close the menu.

## 2.7 Setting of Signal Process

If the reflection from a target you desire to see is unstable, the target is stabilized by rendering the signal process.

Setup: OFF, ON (Initial value: OFF)

- 1 Press the [MENU] key,
- 2 Select [ECHO] → [PROCESS].
- 3 Change the setting of [PROCESS] with the [▲] and [▼] keys.
- 4 Press the [MENU] to close the menu.

## 2.8 Setting of Pulse Width

The short pulse width is suitable for target crowded area. (The resolution is of high priority.)  
 The long pulse width is suitable for searching a small target as the gain increases. (The gain is of high priority.)

Setup: RESO-P PRI., GAIN PRI. (Initial value: GAIN PRI.)

- 1 Press the [MENU] key.
- 2 Select [ECHO] → [PULSE].
- 3 Change the setting of [PULSE] with the [▲] and [▼] keys.
- 4 Press the [MENU] key to close the menu.

The setup of the pulse width is determined by the range.

The setup of the present pulse width is displayed at the left top side of the screen.

SP < M1 < M2 < L1 < L2  
 (Narrowest) (Widest)

☞ For pulse width adjustment, refer to [Pulse Width] of 3.3 Setting of Adjustment Item.

## 2.9 Trailing

By leaving the trail of a target, the situation of the moving target can be seen.

- 1 Press the [MENU] key.
- 2 Select [TRAILS] → [TRAIL MODE].
- 3 Change the setting of [TRAIL MODE] with the [▲] and [▼] keys.
- 4 Select [TRAILS] → [TRAIL TIME].
- 5 Change the setting of [TRAIL TIME] with the [▲] and [▼] keys.
- 6 Press the [MENU] to close the menu.

For the display method, the relative display (R) and the true display (T) are provided.

When changing the range, display mode or display select, the trail disappears.

## Relative Display (R)

The relative speed of a target with respect of own ship is displayed as a trail.

This is used to watch a target which is approaching to own ship. The trail of fixed target such as land, if own ship is moving, will be drawn.

In the illustration below, own ship is moving east at a certain speed and other ship 1 is moving east at the identical speed. And other ship 2 is moving west at the identical speed. After a certain period of time, the trails of three ships are drawn.

The relative speed of a target with respect to own ship is drawn as a trail. Since the ship 2 is moving in the opposite direction at the identical speed, the speed derived by adding the ship 2 speed and own ship speed is drawn as a trail.

The land is drawn as a trail of own ship speed as the land moves at the own ship speed.

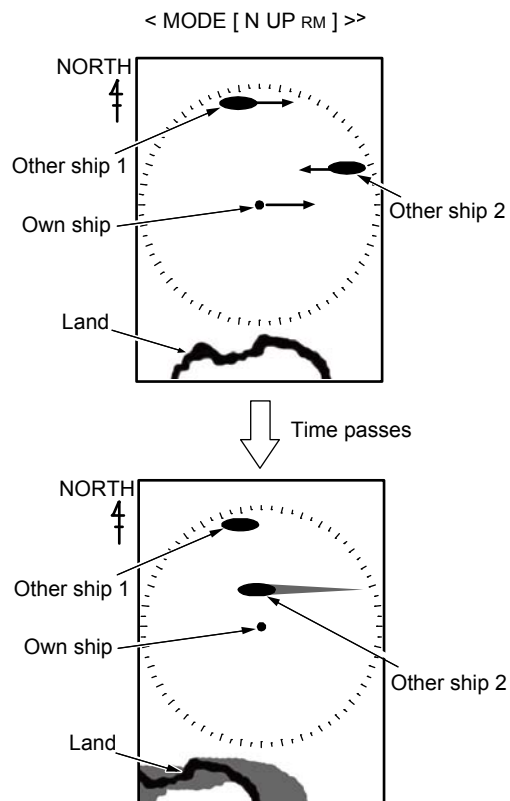

## True Display (T)

Irrespective of the motion of own ship, trails representing the course and speed of moving targets are drawn. This mode is used to monitor the courses and speeds of moving targets. The fixed target such as land is not drawn.

The trails of speeds of own ship, other ship 1 and other ship 2 are drawn. No trail of the land is drawn as it does not move.

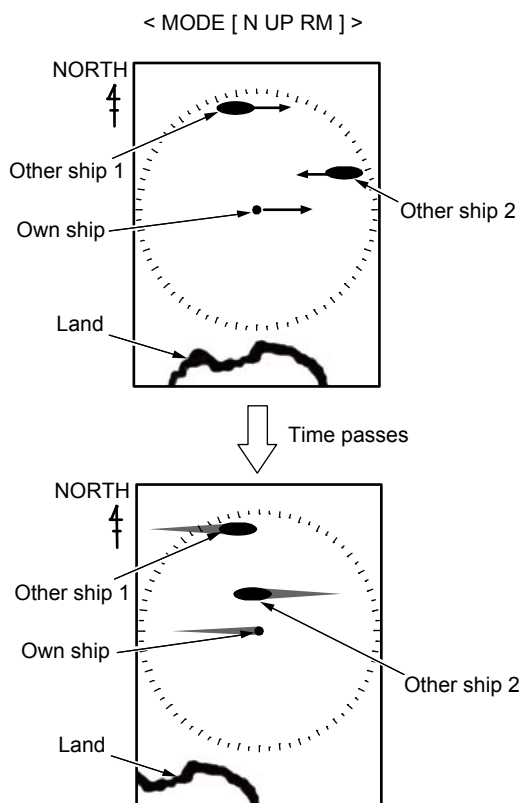

The length of the trail display is specified in [TRAILS] → [TRAIL TIME].

The length is specified by a time, and “One minute” indicates the trail of past one minute. When selecting [OFF], the trail is not displayed.

The shape of trail display is specified in [TRAILS] → [TRAIL SHAPE].

When [STANDARD] is selected, the trail shape of a target does not change as time goes. When [DECREMENT] is selected, the shape of a target becomes narrower as time goes.

The signal level of a target which is left as a trail is specified in [TRAILS] → [TRAIL LEVEL].

By increasing the numeral, only trails of strongly reflected targets can be displayed.

By decreasing the numeral, trails of weakly reflected targets can be displayed.

## 2.10 EBL

This mode is used when measuring the bearing from own ship to a target.

Setup: OFF, ON (Initial value: OFF)

- 1 Press the [MENU] key.
- 2 Select [DISPLAY] → [EBL].
- 3 Change the setting of [EBL] with the [▲] and [▼] keys.

EBL
OFF
ON

- 4 After selecting [ON], press the [▶] key. Then, the EBL can be operated.  
The EBL rotates clockwise with the [▶] key and counterclockwise with the [◀] key.  
The bearing indicated by the EBL is shown at the lower left side of the display.
- 5 Press the [MENU] key to close the menu.

## 2.11 VRM

This mode is used when measuring a distance from own ship to a target.

Setup: OFF, ON (Initial value: OFF)

- 1 Press the [MENU] key.
- 2 Select [DISPLAY] → [VRM].
- 3 Change the setting of [VRM] with the [▲] and [▼] keys.

VRM
OFF
ON

- 4 After selecting [ON], press [▶] key. Then, the VRM can be operated.  
The VRM moves in the far direction with the [▲] key and in the near direction with the [▼] key.  
The distance indicated by the VRM is shown at the lower right side of the display.
- 5 Press the [MENU] key to close the menu.

## 2.12 Display Color

When the display is hard to see due to the environment, changing the color of the display makes it easier to see the contents.

Setup: STANDARD, DAY, NIGHT, USER SET  
(Initial value: STANDARD)

- 1 Press the [MENU] key.
- 2 Select [DISPLAY] → [COLOR].
- 3 Change the setting of [COLOR] with the [▲] and [▼] keys.  
When selecting [DAY], the color of the entire display changes so that it can be seen under the direct sunlight.  
When selecting [NIGHT], the display changes to the color suitable for use at night.  
When selecting [USER SET], the display changes to the color user can set to preference while STANDARD, DAY, NIGHT remain unchanged.
- 4 Press the [MENU] key to close the menu.

## 2.13 Crosshair Cursor Shape

The shape of the crosshair cursor can be changed.

In [LONG], the vertical and horizontal lines of crosshair cursor can be extended to the end of display. It is suitable for grasping the relationship between two remote points.

In [EBL + VRM], the crosshair cursor is the combination of [EBL] + [VRM].  
It is suitable for grasping the relationship between own ship and the target.

Setup: STANDARD, LONG, EBL+VRM (Initial value: STANDARD)

- 1 Press the [MENU] key.
- 2 Select [Display] → [Cursor Shape].
- 3 Change the setting of [Cursor Shape] with the [▲] and [▼] keys.
- 4 Press the [MENU] key to close the menu.

## 2.14 PI (Parallel Index Line)

The straight lines parallel with own ship are displayed.

Setup: OFF, ONE SIDE, BOTH SIDES (Initial value: OFF)

- 1 Press the [MENU] key.
- 2 Select [DISPLAY] → [PI].
- 3 Change the setting of [PI] with the [▲] and [▼] keys.

PI
OFF
ONE SIDE
BOTH SIDES

- 4 After selecting [ONE SIDE] or [BOTH SIDES], press the [▶] key. Then, the parallel cursor can be operated. The distance between parallel lines can be changed with the [▲] and [▼] key and the bearing can be changed with the [◀] and [▶] key.
- 5 Press the [MENU] key to close the menu.  
Set a number of parallel lines in [DISPLAY] → [PI NUMBER].

## 2.15 Bearing Mode

This mode is used when changing the bearing display mode of crosshair cursor and EBL. One setting is the true bearing with the true north set to 0°. The other setting is the relative bearing with the heading set to 0°.

Setup: REL, TRUE (Initial value: REL)

- To display in the true bearing mode, entering the bearing is required, using the optional GPS compass or others.
- 1 Press the [MENU] key.
  - 2 Select [DISPLAY] → [BRG TRUE/REL].
  - 3 Change the setting of [BRG TRUE/REL] with the [▲] and [▼] keys.
  - 4 Press the [MENU] key to close the menu.

## 2.16 Vector

The vector means arrow that represents heading and speeds of own ship and other ships.

The bearing indicated by the arrow denotes the heading and the length of arrow denotes the speed.

The length is specified by time "One minute"

shows the positions of own ship and other ships after one minute.

Setup: 0 to 60min (Initial value: 1min)

- 1 Press the [MENU] key.
- 2 Select [DISPLAY] → [VECTOR].
- 3 Change the setting of [Vector] with the [▲] and [▼] keys.
- 4 Press the [MENU] key to close the menu.

The bearing mode of the vector line is specified in [DISPLAY] → [VECTOR TRUE/REL].

## 2.17 Alarm

This mode is used when monitoring targets. When targets enter in the set range or exit from the set range, the buzzer notifies. Two types [IN] and [OUT] are provided for the alarm mode.

### IN Mode

When a target enters within the specified range, the alarm is issued. This mode is used when watching targets which are approaching to own ship.

### OUT Mode

When a target exits from the specified range, the alarm is issued.

### Setting of Alarm Range

- 1 Press the [MENU] key.
- 2 Select [ALARM] → [ALARM MODE].
- 3 Change the setting of [ALARM MODE] with the [▲] and [▼] keys.

ALARM MODE
OFF
IN
OUT

- 4 After selecting [IN] or [OUT], press the [▶] key. Then, the alarm range can be set.
- 5 Move the crosshair cursor to the center of the alarm range with the [▲], [▼], [◀] and [▶] keys.
- 6 Press the [ENT] key.

- 7 Change the distance direction with the [▲] and [▼] keys and the bearing with the [◀] and [▶] keys.
- 8 Press the [ENT] key. Then, the alarm range is set.
- 9 Press the [MENU] key to close the menu.

The level of targets for alarm is set in [ALARM] → [DETECT LEVEL].

The alarm works when detecting the level higher than the set level.

When [DETECT COUNT] is set, the alarm works depending on the [ALARM MODE] setting.

[IN Mode]: The alarm works when targets enter continuously into alarm area more than [DETECT COUNT] value.

[OUT Mode]: The alarm works when targets leave continuously from alarm area more than [DETECT COUNT] value.

## 2.18 Sleep

The power OFF state and the transmitting state are alternately repeated. This mode saves the power consumption.

The sleep is used in combination with the IN/OUT alarm.

☞ For the setting of the alarm, refer to 2.17 Alarm.

Setup: OFF, 5MIN, 10MIN, 15MIN, (Initial value: OFF)

- 1 Press the [MENU] key.
- 2 Select [ALARM] → [SLEEP].
- 3 Change the setting of [SLEEP] with the [▲] and [▼] keys.
- 4 Press the [MENU] key to close the menu.

### Operation during executing the sleep

During executing the sleep, the transmitting for 30 seconds is repeated at the interval of the set time. If the IN/OUT of a target occurs during transmitting, the buzzer beeps for alarm.

In case that the set time is set to 5 minutes, the sleep works as follows.

Time	30 sec.	2 min. 30 sec.	2 min.	30 sec.	→Hereafter repeated
Antenna	Transmitting	Power OFF	Power On (Countdown)	Transmitting	
LCD/Panel illumination	ON	OFF	ON	ON	

← 5 minutes →

## 2.19 AIS

By installing the optional AIS interface board, the information on other ships, which are received by the AIS receiver, can be displayed.

The other ship symbols of up to 100 ships can be displayed.

**Caution** As the AIS is optional, the menu becomes valid when the AIS interface board is installed.



### Setting of Symbol Display of AIS

- 1 Press the [MENU] key.
- 2 Select [AIS] → [AIS].
- 3 Change the setting of [AIS] with the [▲] and [▼] keys.
- 4 Press the [MENU] key to close the menu.

To change the region to display the other ship's symbol, set it in [AIS] → [LIMIT]. Only other ship's symbols within the radius of the set distance from own ship placed in center can be displayed.





### Setting of Detailed Information of Designated Symbol Display

The information display is set in [AIS] → [INFO], [INFO NUMBER]. The other ship's information of the designated number is displayed at the bottom of the display.

- 1 Press the [MENU] key.
- 2 Select [AIS] → [INFO].
- 3 Change the setting with the [▲] and [▼] keys.
- 4 Select [AIS] → [INFO NUMBER].
- 5 Select the number with the [▲] and [▼] keys.
- 6 Press the [MENU] key to close the menu.

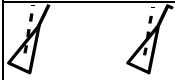
### Types and Meanings of AIS Symbols

In the AIS, the symbols are displayed, overlaying them on other ships from which the information is derived.

Normal Symbol	Meanings
	Sleep Display* Displays ships of which information display is not performed.
	Active Display** Displays ships which are performing the information display or after performing it. The dotted line denotes the speed and the real line denotes the heading. The line perpendicular to the heading direction denotes the course direction.
	Displays ATON (Aids to navigation) and Base.
	Displays ships while selecting the detailed information display. The detailed information display is shown at the bottom of the display.
Alarm Symbol	Meanings
	Displayed when the values are lower than the set CPA and TCPA, and get alarm.
	Displays lost ships during tracking. In case that ships are lost from the sleep, the alarm does not sound and they disappear from the screen.

\*: When active target gets out of the screen and again into the screen, the target automatically changes to sleep target. (The above could be happen at the time of target vessel moving out, RANGE shifting, and OFF-CENTER shifting.)

\*\* : To change from the sleep display to the active display, after setting ON in [AIS] → [INFO], change the number in [AIS] → [INFO NUMBER].

Or register [OTHER SHIP] to [F1] key or [F2] key, and place crosshair cursor to the target you would get the information and press [F1] key or [F2] key.

**Warning**

The accuracy of the data provided by the AIS could be affected by the following factors:

Degraded bearing data and latitude/longitude from external sensor devices cause erratic vectors. If any error data fed from external sensor devices are detected, the following data provided by the AIS display will be also erratic.

- The CPA and TCPA value and Alarm.
- The target ship's course and speed.
- The target ship's bearing and distance.

**2.20 ATA**

To use the ATA, install the optional ATA board. The ATA automatically tracks targets and stores and displays their courses and speeds as vectors.

Entering the heading bearing and ship speed are required, using the optional GPS compass or others.

After tracking, targets are displayed as a vector of course and speed.

An object, which is acquired and tracked, is called a target.

**Caution**

As the ATA is optional, the menu becomes valid only when the ATA board is installed.

To activate ATA, the bearing and the speed information of own ship needs to be input. The bearing signal shall be such high speed and highly accurate signals as from GPS COMPASS. GPS bearing only tends not to be enough to operate ATA normally.

**Warning**

The accuracy of the auto tracking function provided by the ATA could be affected by the following factors:

- (1) Sea clutter and weather clutter such as rain and snow may degrade the ATA tracking capability. These clutter components should be appropriately reduced.
- (2) Poor receiver sensitivity may also degrade the tracking capability.
- (3) Faulty azimuth synchronization could be the cause of erratic vectors.
- (4) Degraded bearing and speed data fed from external sensor devices also cause erratic vectors.

If any of the errors stated above are detected, the following data provided by the ATA will be erratic.

- The CPA, TCPA value and Alarm.
- The target ship's course and speed.
- The target ship's bearing and distance.

**Automatic Acquisition**

Targets entering in the preset range can be automatically acquired.

- 1 Press the [MENU] key.
- 2 Select [ATA] → [AUTO DETECT AREA].
- 3 Change the setting of [AUTO DETECT AREA] with the [▲] and [▼] keys.
 

AUTO DETECT AREA
OFF
ON
- 4 After selecting ON, press the [▶] key. Then, the automatic acquisition range can be set.
- 5 After moving the crosshair cursor to the center of [AUTO DETECT AREA] with the [▲], [▼], [◀] and [▶] keys.
- 6 Press the [ENT] key.
- 7 Change the distance with the [▲] and [▼] keys and bearing with the [◀] and [▶] keys.
- 8 Press the [ENT] key. Then, the [AUTO DETECT AREA] is set.
- 9 Press the [MENU] key to close the menu.

## Manual Acquisition

Direct to acquire a target by designating a target on the display.

- 1 Press the [MENU] key.
- 2 Select [ATA] → [ACQ].
- 3 Press the [▶] key.
- 4 Align the crosshair cursor with a target you desire to acquire with the [▲], [▼], [◀] and [▶] keys.
- 5 Press the [ENT] key. Then, the acquisition of the designated target is started.
- 6 When acquiring several targets, repeat steps 4 and 5.
- 7 Press the [MENU] key to close the menu.

## Target Level

The signal level of a target to be automatic/manual-acquisition is specified in [ATA] → [ATA TGT LEVEL].

By increasing the numeral, a strongly reflected target can be acquired.

By decreasing the numeral, a weakly reflected target can be also acquired.

## Target Delete

Release the acquisition of a target.

- 1 Press the [MENU] key.
- 2 Select [ATA] → [DELETE].
- 3 Press the [▶] key.
- 4 Change the setting of [DELETE] with the [▲] and [▼] keys.

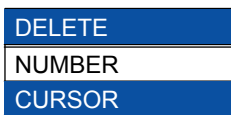

- 5 After selecting [NUMBER] or [CURSOR], press the [▶] key. Then, the number designation or the cursor designation can be set.
- 6
  - In case of [MAN ACQ NUM], change the number to be deleted with the [▲] and [▼] keys.
  - In case of [CURSOR], align the crosshair cursor with the target you desire to delete with the [▲], [▼], [◀] and [▶] keys.

- 7 Press the [ENT] key. Then, the acquisition of the designated target is released.

- 8 When releasing acquisition of several targets, repeat steps 6 and 7.

- 9 Press the [MENU] key to close the menu.

To release acquisition of all targets, execute [ATA] → [ALL DELETE].

## Number of Acquisition

A total number of targets to be acquired is 50 targets when combined in both automatic/manual methods.

The number specified in [ATA] → [MAN ACQ NUM] becomes a number of targets to be manually acquired. And the rest becomes a number of targets to be automatically acquired.

- 1 Press the [MENU] key.
- 2 Select [ATA] → [MAN ACQ NUM].
- 3 Change the setting of [MAN ACQ NUM] with the [▲] and [▼] keys.
- 4 Press the [MENU] key to close the menu.

## Information Display

The information display is set in [ATA] → [INFO] or [INFO NUMBER].





The target information of the designated number is displayed at the bottom of the display.

- 1 Press the [MENU] key.
- 2 Select [ATA] → [INFO].
- 3 Change the setting with the [▲] and [▼] keys.
- 4 Select [ATA] → [INFO NUMBER].
- 5 Select the number with the [▲] and [▼] keys.
- 6 Press the [MENU] key to close the menu.



## Types and Meanings of ATA Symbols

In the ATA, the symbols are displayed, overlaying on acquire-started targets.

Normal Symbol	Meanings
	Displayed when setting the acquisition.
	Displayed when in the stable tracking state.
	Displayed when numeral-displayed after the stable tracking state.
Alarm Symbol	Meanings
	Displayed when the values are lower than the set CPA and TCPA.
	Displayed when targets become in the tracking inability state. After 1 minute, the alarm sounds. After 5 seconds, both the display and the alarm disappear.

### NOTE:

The ATA vector and the AIS vector may differ in terms of the vector length and its direction. This is not a fault. The ATA vector is developed based on the past target positions stored either by automatic tracking (ATA). Meanwhile, the AIS vector is generated from the navigation data sent from the AIS transponder. The ATA vector take a certain time until they are fully displayed, while the AIS vector is displayed as soon as the AIS data is received from the AIS transponder and own GPS/SHIP information.

## Chapter 3 How to use the system menu

### 3.1 Display of System Menu

There is a standard menu which is displayed for the first time after pressing the [MENU] key and following a system menu which is not frequently required to change the setup.

- ASSIST
- ADJUST
- NMEA
- PRESET
- MAINTE

#### Display the system menu

- 1 Press the [MENU] key.
- 2 Select [Next] with the [▲] and [▼] keys.

ECHO	ASSIST
TRAILS	ADJUST
DISPLAY	NMEA
ALARM	PRESET
AIS	MAINTE
ATA	
NEXT	

- 3 Press the [▶] key.  
The system menu appears.

PREV	RANGE RINGS	ON
ASSIST	RANGE UNIT	NM
ADJUST	SPEED UNIT	kn
NMEA	TEMP UNIT	°C
PRESET	DEPTH UNIT	m
MAINTE	POSITION DISPLAY	OWN POSITION
	WPT DISPLAY	OFF
	ROTATION SPEED	HIGH SPEED
	NEXT	

#### Return to the normal menu

- 1 Select [Prev] with the [▲] and [▼] keys.
- 2 Press the [▶] key.  
The normal menu appears.

### 3.2 Setting of Assist Items

In the supplement items of the system menu, to use the radar effectively, the supplement functions are set.

#### Range Rings

The fixed marker is displayed at the constant distance from own ship's position. It is used as a scale to measure roughly the distance of a target.

Setup: OFF, ON (Initial value: OFF)

#### Range Unit

Set the unit of distance (range, VRM distance).

Setup: NM, km, sm (Initial value: NM)

#### Speed Unit

Set the unit of speed.

Setup: kn, km/h, m/h (Initial value: kn)

#### Temperature Unit

Set the unit of water temperature.

Setup: °C, °F (Initial value: °C)

#### Depth Unit

The unit of water depth is set.

Setup: m, fm, l.fm, ft, J.fm (Initial value: m)

#### Position Display

The content of position informatin displayed at the lower left of the display is set.

Setup: OFF, OWN Position, WPT position, POB Position (Initial value: OWN Position)

### **WPT Display**

Select ON or OFF of the WPT icon (flag mark) to be displayed on the radar screen.

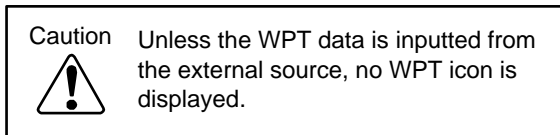

Setup: OFF, ON (Initial value: ON)

### **Rotation Speed**

Set the rotation speed of the radar image by inputting bearing data in the H UP mode or WPT UP mode.

Setup: STANDARD, HIGH SPEED (Initial value: HIGH SPEED)

### **ALL PPI**

Select ON or OFF of the background of numerical information displayed near the image when the PPI display is selected.

Setup: OFF, ON (Initial value: ON)

### **Guide**

Select ON or OFF of the display of operation guide when operating the menu.

Setup: OFF, ON (Initial value: ON)

### **Buzzer**

Set ON or OFF of the buzzer sound. The ON/OFF of external buzzer (optional) sound is also set.

Setup: OFF, ON (Initial value: ON)

### **Motor Speed**

Set the rotational speed of the antenna. During the antenna rotation, the setting cannot be changed.

Setup: OFF, ON (Initial value: OFF)

### **N UP/S UP**

Change the mode of the N UP or S UP of the display mode.

The selected item can be selected in [ECHO] → [MODE].

Setup: N UP, S UP (Initial value: N UP)

### **Crosshair Cursor Display**

Set the indication methods of the crosshair cursor.

When [OPERATING] is selected, crosshair cursor is displayed on the radar screen only when operated and disappears 30 seconds after operation is stopped.

Setup: ALWAYS, OPERATING (Initial value: ALWAYS)

### **Radar Setting Display**

Set ON or OFF of the radar setting indication status shown in upper portion of the screen.

When [OFF] is selected, the minimum information required is only displayed on the radar screen.

Setup: OFF, ON (Initial value: ON)

### **Menu Operation**

Select the type of the operation methods in the menu.

Setup: A, B (Initial value: A)

## **3.3 Setting of Adjustment Items**

In the adjustment items of the system menu, when using the radar, the initial adjustment and setup are performed. When setting the adjustment item, set the screen brightness to maximum.

 For screen brilliance, refer to 1.4 Brilliance Adjustment.

## Bearing Setting

Adjust the bearing of the radar image on the screen.

Setup: -180.0 to +180.0 (Initial value: 0.0)

- 1 Press the [STBY/TX] key to start the transmission.
- 2 Set the range of the display to more than 1nm with the [- RANGE +] key.
- 3 Press the [MENU] key.
- 4 Move to the system menu.  
☞ Refer to 3.1 Display of System Menu.
- 5 Select [ADJUST] → [BRG ADJ].
- 6 Change the setting of [BRG ADJ] with the [▲] and [▼] keys.  
When increasing the numeral, the radar image moves clockwise.  
When decreasing the numeral, the radar image moves counterclockwise.  
Change the bearing so that the bearing of the image of a target becomes the same bearing as measured by the compass.

## TX Delay Adjustment

By adjusting the delay time of the transmission, match the distance of the target on the radar screen with the distance of the actual target. To adjust precisely, select a nearest hard straight object (pier) (within 100m). Adjust the transmission delay time in the following procedure.

Setup: 0 to 255 (Initial value: 20)

- 1 Press the [STBY/TX] key to start the transmission.
- 2 Set the range of the display to more than 0.125nm with the [- RANGE +] key.
- 3 Press the [MENU] key.
- 4 Move to the system menu.  
☞ Refer to [3.1 Display of System Menu].
- 5 Select [ADJUST] → [TX DELAY ADJ].
- 6 Change the setting of [TX DELAY ADJ] with the [▲] and [▼] keys.  
When the echo reflected from the target warps to near, decrease the value.  
When the echo reflected from the target warps to far, increase the value.  
As illustrated below (Figure of center), adjust so that the straight target is straightly

displayed on the screen.

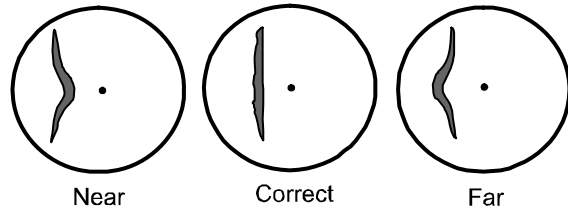

## MBS

Set the MBS to suppress and cancel the disc-like transmission leak at the center of the image as shown below.

Setup: 0 to 100 (Initial value: 20)

- 1 Press the [STBY/TX] key to start the transmission.
- 2 Set the [GAIN] knob to 8, the [STC] knob to 0 and the [FTC] setting to [OFF].
- 3 Set the range of the display to 0.125nm with the [- RANGE +] key.
- 4 Rotate the [STC] knob so that the disc-like transmission leak is displayed at the rotational center of the image.
- 5 Move to the system menu.  
☞ Refer to 3.1 Display of System Menu.
- 6 Select [ADJUST] → [MBS].
- 7 Change the setting of [MBS] with the [▲] and [▼] keys.  
Adjust while observing the disc-like transmission leak.  
When the transmission leak disappears, the MBS is best adjusted.

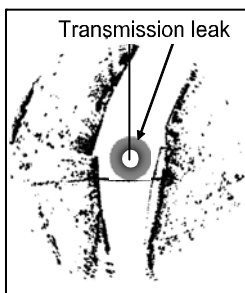

Number of MBS is [Small]

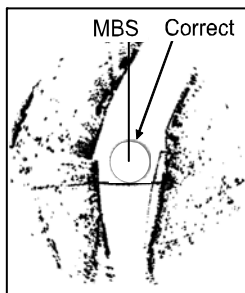

Number of MBS is [Correct]

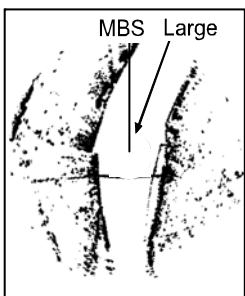

Number of MBS is [Large]

### STC Curve

Influence from the ocean surface reflection depends on the installation height of antenna. Please proceed with the following sequence, when STC curve is modified.

Setup: 1 to 8 (Initial value: 4)

**Note:** Set the STC curve after the gain setting. When setting the STC curve, go out of the harbor and perform at the location where the reflection from sea surface is displayed on the radar screen.

- 1 Set the [GAIN] knob to 8, the [STC] knob to 0 and the [ECHO] → [FTC] setting to [OFF]. Adjust so that the noise-like sea surface reflected echo is displayed at the center of the image as shown below.

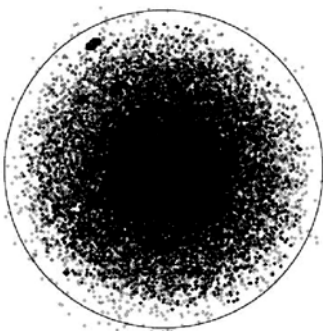

- 2 Press the [- RANGE +] key to select the

range that can display the entire sea surface reflected echo can be displayed.

- 3 Adjust the [STC] knob and stop it just before the sea surface reflected echo completely disappears (In the state that the sea surface reflected echo is sparsely displayed.) As shown in [Proper] below, when the sea surface reflected echo from near to far distance disappears evenly, the STC curve set value is proper. As shown in [Large], when the sea surface reflected echo at near distance disappear first, or in [Small], when the sea surface reflected echo at far distance disappears first, it is necessary to change the setting in the procedure described in the following items.

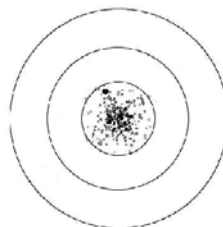

Number of STC Curve is [Small]

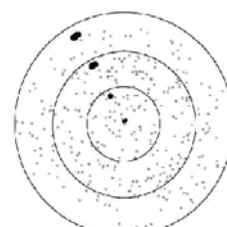

Number of STC Curve is [Correct]

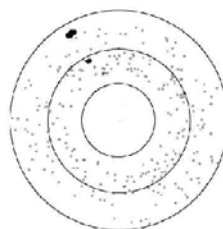

Number of STC Curve is [Large]

- 4 Press the [MENU] key.
- 5 Move to the system menu.  
☞ Refer to 3.1 Display of System Menu.
- 6 Select [ADJUST] → [STC CURVE].
- 7 Change the setting of [STC CURVE] with the [▲] and [▼].  
When the sea surface reflected echo at near distance disappears first, decrease the value.  
When the sea surface reflected echo at far distance disappears first, increase the value.
- 8 Adjust the [STC] knob again.  
Adjust so that the sea surface reflected echo from near to far distance disappears evenly as shown in the illustration [Correct] in step 3.

The STC curve set value is applied to all ranges.

**Note: The setting of STC characteristics needs to be performed in the ocean. However, when it is obliged to perform in a harbor, set the STC curve to [4].**

### Tune Select

Due to an operation environment change, tuning of the transmission frequency with the reception frequency may be detuned. If detuned, the gain will decrease and it is hard to display the image even if setting remains unchanged.

Setup: AUTO, MANUAL (Initial value: AUTO)

### Automatic Tuning

For the best performance, when newly installing or replacing the magnetron, the automatic tuning should be adjusted.

Unless the auto tune is adjusted, the optimum gain is not achieved.

Setup: 0 to 100 (Initial value: 31)

- 1 Press the [STBY/TX] key to start the transmission.
- 2 Set the range of the display to more than 12nm with the [- RANGE +] key. Find a large and stable target of more 6nm (mountain or island) at farthest location as possible.
- 3 Adjust by rotating the [GAIN] knob so that the target is faintly visible.
- 4 Press the [MENU] key.
- 5 Move to the system menu.  
☞ Refer to 3.1 Display of System Menu.
- 6 Select [ADJUST] → [TUNE SELECT], and then [AUTO].
- 7 Select [ADJUST] → [AUTO TUNE ADJ].
- 8 Change the setting of [AUTO TUNE ADJ] with the [▲] and [▼] keys. Maximize the size of fixed target on the screen. If the target becomes too large and the best tuning point is lost, reduce the gain with the [GAIN] knob once to make its size small and maximize the target with the [▲] and [▼] keys.

### Manual Tune Adjustment

Due to a sudden environment change, the automatic tuning may be detuned. In this case, use the manual tune adjustment.

Setup: 0.0 to 100 (Initial value: 44.0)

- 1 Press the [STBY/TX] key to start the transmission.
- 2 Set the range of the display to more than 12nm with the [- RANGE +] key. Find a large and stable target of more than 6nm (mountain or island) at farthest location
- 3 Adjust by rotating the [GAIN] knob so that the target is faintly visible.
- 4 Press the [MENU] key.
- 5 Move to the system menu.  
☞ Refer to 3.1 Display of System Menu.
- 6 Select [ADJUST] → [TUNE SELECT], and then [MANUAL].
- 7 Select [ADJUST] → [MANUAL TUNE ADJ].
- 8 Change the setting of [MANUAL TUNE ADJ] with the [▲] and [▼] keys. Maximize the size of fixed target on the screen. If the target becomes too large and the best tuning point is lost, reduce the gain with the [GAIN] knob once to make its size small and maximize the target with the [▲] and [▼] keys.

### Pulse Width

In [2.8 Setting of Pulse Width], [RESO-P PRI.] or [GAIN PRI.] is selected. At this moment, the pulse width (Displayed at the upper left of the display.) can be changed.

This setting can be set for only the range (0.75 – 8).

Setup: SP, M1, M2, L1, L2

- 1 Press the [MENU] key.
- 2 Move the system menu.  
☞ Refer to 3.1 Display of System Menu.
- 3 Select [ADJUST] → [PULSE WIDTH].
- 4 Select the range in which the pulse width adjustment is performed with the [▲] and [▼] keys, and press the [▶] key.

- 5 Change the setting of [Pulse Width Adjustment] with the [▲] and [▼] keys.

The content of the set value of [PULSE WIDTH] is as follows.

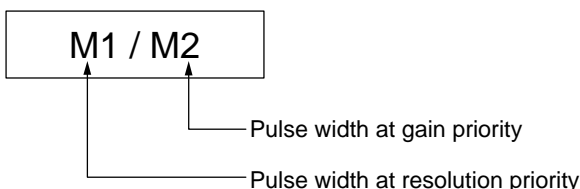

The length of pulse width varies as shown below.

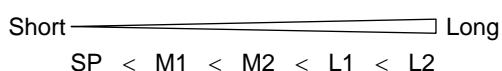

### Interference Rejection

This feature is used to eliminate the radar interference wave from other radars. When radars having the same frequency band as your radar are used near your ship, the interference noise from transmission signals of other radars appears on the radar screen. Though the appearance of the interference is not uniform, in most cases, this interference noise pattern is spiral or a radiation form. This unit can reduce the interference with the interference rejection function.

Setup: OFF, 1, 2 (Initial value: 2)

- 1 Press the [MENU] key.
- 2 Move to the system menu.  
☞ Refer to 3.1 Display of System Menu.
- 3 Select [ADJUST] → [IR].
- 4 Change the setting of [IR] with the [▲] and [▼] keys.  
The greater the numeral is the stronger the interference rejection.  
If the interference rejection effect is too strong, it is hard to see small targets.  
So be cautious not to set it stronger.

### Echo Color Divide

The color of an image can be changed to make it easier to see.

Setup: STANDARD, DETAIL (Initial value: STANDARD)

- 1 Press the [MENU] key.
- 2 Move to the system menu.  
☞ Refer to 3.1 Display of System Menu.
- 3 Select [ADJUST] → [ECHO COLOR DIV].
- 4 Change the setting of [ECHO COLOR DIV] with the [▲] and [▼] keys.

[STANDARD]: Standard color

[DETAIL]: Displays many middle colors so that the strength or weakness of the echo can be discriminated.

### Signal Select

Select the input signal of the image from antenna, monitor and demo.

Setup: ANTENNA, MONITOR, DEMO (Initial value: ANTENNA)

- 1 Press the [MENU] key.
- 2 Move to the system menu.  
☞ Refer to 3.1 Display of System Menu.
- 3 Select [ADJUST] → [SIGNAL SELECT].
- 4 Change the setting of [SIGNAL SELECT] with the [▲] and [▼] keys.

[ANTENNA]: In case that the input signal of the image is antenna:

[MONITOR]: In case that two units are connected and used as a monitor

[DEMO]: The Fixed video is displayed.

### Field of Angle

Due to the installing position of the display unit, if it is hard to see the screen, it can be improved by adjusting this setting.



Setup: 0 to 50 (Initial value: 0)

- 1 Press the [MENU] key.
- 2 Move to the system menu.  
☞ Refer to 3.1 Display of System Menu.
- 3 Select [ADJUST] → [FIELD OF ANGLE].
- 4 Change the setting of [FIELD OF ANGLE] with the [▲] and [▼] keys.  
When increasing the numeral, the visibility angle is widened.  
However, if the field of angle is widened too much, it is hard to see the image from front.

### 3.4 NMEA

In the NMEA item of the system menu, the transmission speed of the external input/output can be changed.

Match the transmission speed with that of the external connection equipment.

- 1 Press the [MENU] key.
- 2 Move to the system menu.
  -  Refer to 3.1 Display of System Menu.
- 3 Select [NMEA] → [CH1 (J3)] or [CH2 (J4)]. Select the connector of which the transmission speed is changed.
- 4 Change the setting of transmission speed with the [▲] and [▼] keys.
- 5 Press the [▶] key to display the NMEA monitoring menu.
  - If the external equipment is connected at the correct transmission speed, the received NMEA sentence is displayed.
  -  For the NMEA sentence, refer to 5.6 List of Input/Output sentence.

### KGC-1 Setting (Connection with the KODEN GPS compass)

In case KGC-1/KGC-222 (GPS compass) is connected to CH2 (J4), the best performance can be achieved by executing [KGC-1 SETTING],

- 1 Press the [MENU] key.
- 2 Move to the system menu.
  -  Refer to 3.1 Display of System Menu.
- 3 Select [NMEA] → [KGC-1 SETTING], and press the [▶] key
- 4 Press the [ENT] key.
- 5 Select [Yes] with the [▲] and [▼] keys.
- 6 Press the [ENT] key.

Both the display unit and the GPS compass are properly set.

The HDT, GGA and VTG signals are outputted from the GPS compass, and baud rate is set to 38,400.

### 3.5 Preset

In the Preset of the system menu, the radar is customized.

#### F1/F2 Key Set

Select the function assigned to F1 and F2 keys.

#### Select Range S/M/L

Select the range to be set with the [- RANGE +] key.

#### Echo Color Set

Set an arbitrary color to the video color.

#### Trail Color Set

Set an arbitrary color to the trail color.

#### Display Color Set

Set an arbitrary color to the color of cursor and numerals.

#### Language Select

Select the language used in the menu.

#### NAV Display Select

When [DISPLAY SELECT] is set to [PPI/NAV], set the content to be displayed on the NAV display.

#### Camera Position Correction

The CCD camera video displayed by pressing the [STC] knob may be shifted.

By performing [CAMERA POSITION], the display position of CCD camera video can be corrected in the upper and lower directions.



## 3.6 Maintenance

The self-diagnosis of the system menu is the menu for maintenance. Normally, it is not used. Perform the self-diagnosis of the display unit and the antenna.

### Display Unit

The state of the display unit is displayed.  
The version of the system program is displayed.

### Antenna

The state of the antenna is displayed.  
The type of antenna connected and the state of voltage are displayed.

### Panel Test

Testing the operation block is performed.

### LCD Test

Testing the LCD is performed.

### Operation Hours Reset

The memorized operating hours are reset.

### TX Hours Reset

The memorized transmitting time is reset.

### All Reset

The internal memory is reset.  
All of the set values are returned to the factory-settings.

### System Program Renewal

The system program is renewed from the external equipment.

# Chapter 4 Maintenance

## 4.1 Maintenance

To operate the radar equipment in a good condition for a long period of time, perform the inspection and cleaning periodically.

### 4.1.1 Monthly Inspection

 Caution: Before starting the inspection, ensure to turn off the power of the radar equipment.

 Do not turn on the power of the radar during inspection.

- (1) To protect the LCD and enhance the visibility, the acrylic filter is installed on the surface. If the acrylic filter is dirty, an image cannot be clearly seen. If dirty, dip a soft cloth into a neutral detergent, wring it lightly and wipe the filter surface lightly with the cloth. Do not use a dry cloth. If done so, due to static electricity, the acrylic filter will attract dust.

 Caution Never use a thinner solvent. The filter surface will be chemically decomposed, resulting in the loss of the transparency.

- (2) Check that the radiation surface of the antenna is not dirtied by soot. Dip a soft cloth into water or soap water, wring lightly and wipe the antenna with the cloth. Check for damage and paint sticking.

**Note: Before performing the maintenance and inspection of the antenna, thread a string through the hole of radome (upper) as illustrated below and hang it up.**

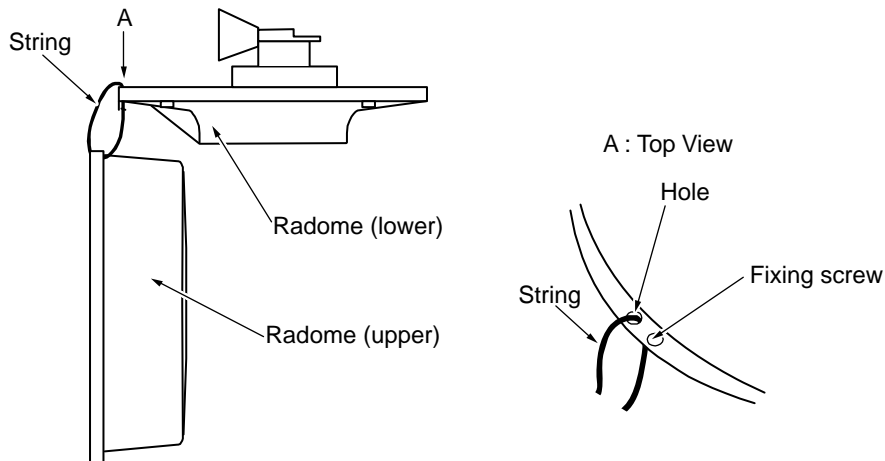

### 4.1.2 Yearly Inspection

In case of Open antenna (RB716A), check the brush of the antenna drive motor inspect every 2,000 hours of transmission. If the length is shorter than 6mm, replace it with a new one.

Press the [MENU] key and select [MAINTE] → [DISPLAY UNIT], message of transmission time is displayed.

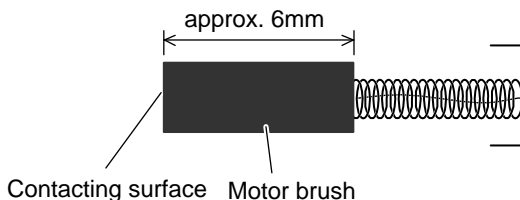



**WARNING:** Before opening the cover of the antenna, be sure to turn off the power of the radar equipment to avoid the electrocution.

- (1) Loosen the fixing screws and remove the cover of the antenna at the bow side. The antenna drive motor can be seen at the lower side in the cabinet.
- (2) Referring to the illustration below, remove the motor brush with flat screw driver.
- (3) Insert the screwdriver in the groove of the brush and rotate it counterclockwise and slowly. Be sure to replace both brushes at both sides.
- (4) Insert new brushes and install the brushes in reverse steps.

Inside of Scanner unit

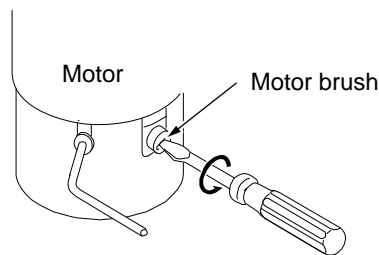
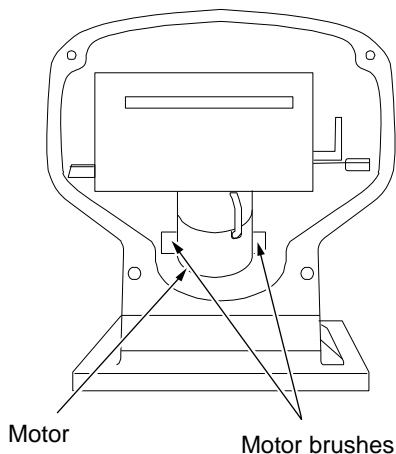

To remove the motor brush, turn it counterclockwise and slowly with the screwdriver.

## 4.2 Fuse Replacement

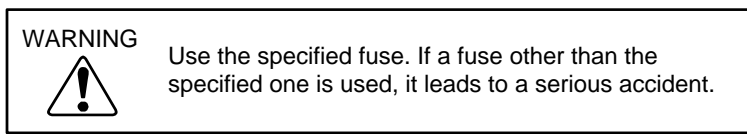

If the input voltage is too high, hyper-current flows or a trouble occurs inside, the fuse blows out. The fuse is housed in the rear side of the Display unit.

## 4.3 Consumables

This unit employs the magnetron which is the consumables and needs the replacement periodically. The magnetron is housed in the Scanner unit. When it is hard to see an image at a far distance, the magnetron may be deteriorated. In this case, replace the magnetron. When replacing, consult your sales dealer.

Press the [MENU] key and select [MAINTE] → [DISPLAY UNIT], message of transmission time is displayed.

Replacement target: Normally 3,000 hours

## 4.4 Trouble Diagnosis

In this chapter, for finding a troubled location on a ship, a simple troubleshooting is mentioned.

### 4.4.1 Information required for requesting a repair

Inform us of the following items.

- (1) Name of ship, telephone number if the satellite communication system is equipped
- (2) Type of equipment
- (3) Manufacturing number of the equipment
- (4) ROM version (Press the [MENU] key and select [MAINTE] → [DISPLAY UNIT], message of ROM version is displayed.)
- (5) Port of next arrival, arrival schedule and dealer name
- (6) Trouble situation and inspected result on a ship

### 4.4.2 Error Display

When a trouble occurs in the equipment or by miss-operation, the content of the troubles are displayed on the radar screen. The error, alarm and warning are provided at the time of troubles. When a trouble is confirmed in the radar, after recording the trouble classification, abnormal location and abnormal content, press the [ENT] key. And then alarm and error display will disappear.

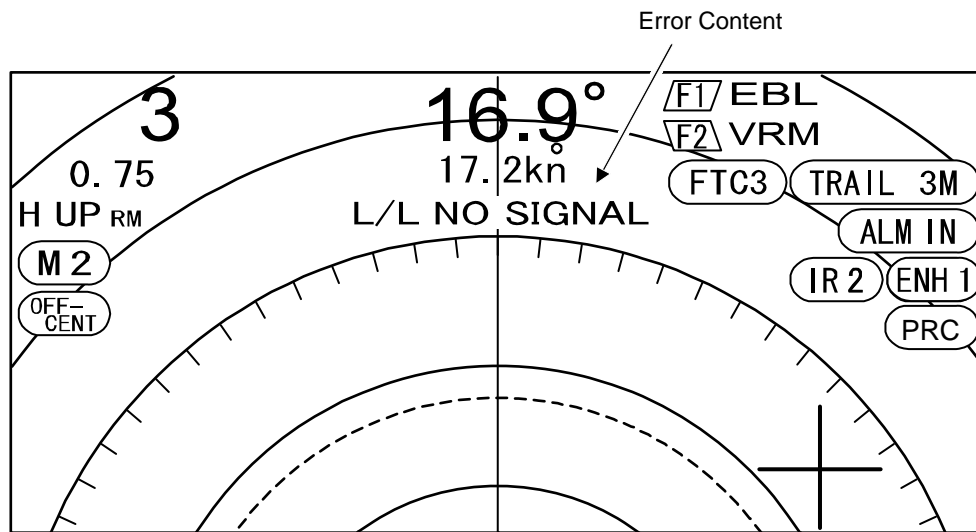

Error Display	Causes
L/L NO SIGNAL	The latitude and longitude is not entered.
HDG NO SIGNAL	The bearing signal is not entered.
SPD NO SIGNAL	The ship speed signal is not inputted.
ANTENNA ERROR 1	The trigger signal is not inputted from the antenna.
ANTENNA ERROR 2	The video signal is not inputted from the antenna.
ANTENNA ERROR 3	The heading signal is not inputted from the antenna.
ANTENNA ERROR 4	The auto tune is abnormal.
ANTENNA ERROR 5	The transmission voltage (+250V) is abnormal.
ANTENNA ERROR 6	The magnetron current is abnormal.
ANTENNA ERROR 7	The heater voltage of the magnetron is abnormal.

#### 4.4.3 Self-diagnostic Function

The self-diagnostic menu is provided in the equipment.

Referring to 3.6 Maintenance, check for the abnormality of the radar.

#### 4.4.4 Inspection at Each Location

After finishing the inspection by the self-diagnosis, according to the table, check each location of the radar.

Trouble conditions	Suspected causes of troubles	Countermeasures
The radar cannot be powered.	The power cable is not connected.	Connect the power cable and fix the connector firmly.
	The power voltage is out of the specified range.	Use the appropriate power.
	The main power fuse blew out.	Replace the fuse with a new one.
The radar can be powered. But, nothing is displayed on the screen.	The screen brightness adjustment is set to the minimal value.	Adjust the brightness with the [BRILL] key.
	Defect of the LCD unit	Request the repair.
	Defect of the LCD drive circuit	Request the repair.
The screen is dark.	The screen brightness adjustment is not properly performed	Adjust the brightness with the [BRILL] key.
	Defect of the backlight	Request the repair.
The character information can be displayed. But, the image of the radar cannot be displayed.	The mutual connection cable is not connected.	Connect correctly the mutual connection cable.
	Detuned.	Re-adjust. ☞ Refer to Tune Select in 3.3 setting of Adjustment Items.
	Defect of the transmission equipment	Request the repair.
The target image is different from the actual one.	The heading is not correctly set.	Set the heading. ☞ Refer to Bearing Setting in 3.3 Setting of Adjustment Items.
	The distance adjustment is not properly set.	Set correctly the TX delay adjustment. ☞ Refer to TX Delay in 3.3 Setting of Adjustment Items.
The image is weak.	The set value of the gain is low.	Rotate clockwise the [GAIN] knob to display an image.
	The setting defect of STC or FTC.	Re-adjust. ☞ Refer to 1.8 STC Adjustment or 2.2 FTC Adjustment.
	Detuned.	Re-adjust. ☞ Refer to Tune Select in 3.3 Setting of Adjustment Items.
	Defect of the magnetron or MIC (front end)	Request the repair.
Too much noise	Detuned.	Re-adjust. ☞ Refer to Tune Select in 3.3 Setting of Adjustment Items.
	The radar is not grounded.	Connect the ground wire.
The antenna does not rotate.	The power is not fed to the motor.	Check the connection of the motor power.
	The motor brush is worn.	Replace the motor brush with a new one.

## Chapter 5 Equipment

### 5.1 Antenna Installation

#### Determining the location of the installation

The search capability of the radar varies largely, depending on the position of the antenna installation. The ideal installation position is the high place over the keel line where no obstacle surrounds. Actually, though there are many limitations in a ship, determine the installation position, considering the following items.

1. The antenna block should be over the line drawn between the bow and the stern, and should be installed to a position where no obstacle to block the radiation path of the radar beam is present.
2. To avoid the electromagnetic wave interference with human bodies, install the antenna block higher than the living space by 0.6m. However, if installed at the higher position, objects at the near distance cannot be searched. Thus, when approaching to a pier, if the radar is used, you must pay attention.  
The higher the position of the antenna is, the stronger the reflection from the sea surface becomes.
3. Keep the surface of the platform, where the antenna is installed, horizontal as possible to be parallel with the sea surface.
4. Install the antenna lock in front of the large structure and exhaust chimney to avoid the blind sector (inability angle of image search) on the screen and to prevent the opening of the antenna from being dirtied by the engine exhaust.
5. Keep enough space for maintenance.
6. To prevent a blind or ghost from occurring in the heading, place the antenna towards the bow rather than obstacles, keep it away from obstacles. And when installing the antenna on the mast, place it in front of the mast. (If obstacles cannot be avoided due to limitation of structure, refer to [How to shift the antenna from an obstacle] described later.
7. Keep away the antenna from other equipment's antenna.  
Keep a distance from antennas of a direction finder and a VHF transmitter-receiver as far as possible.
8. Keep a distance for safety from the magnetic compass.

Safety Distance from Magnetic Compass

Type of drive	Standard Compass	Steering Compass
RB714A	2.0m	1.4m
RB715A	2.0m	1.4m
RB716A	2.0m	1.4m

**WARNING**



Install the antenna, keeping it away from wireless equipment not to be interfered.

**How to shift the antenna from an obstacle**

**1. How to shift the antenna from the keel line**

By shifting the antenna from keel line to the starboard, the blind moves to the port and the visibility in the heading can be secured. According to a distance to an obstacle, the distance to be shifted can be derived from the formula below.

$L_s = 0.4R + D/2$  [m] ( $R < 15$  m)  
 $L_s = 0.025R + D/2$  [m] ( $R \geq 15$  m)  
 $L_s$  : Distance to be shifted from the keel line  
 $D$  : Diameter of an obstacle over the keel line  
 $R$  : Distance to an obstacle

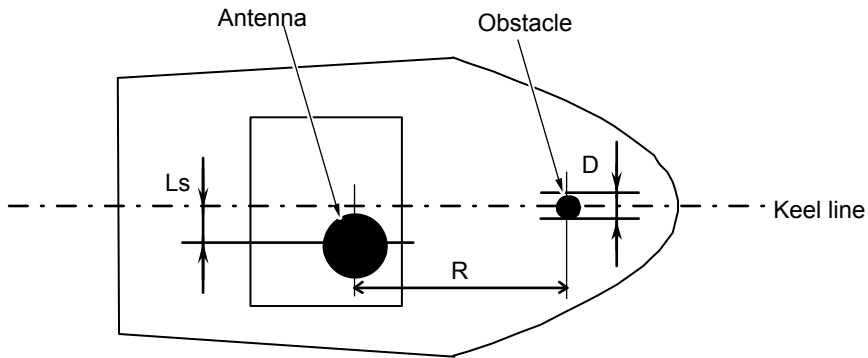

How to shift the antenna from the keel line

**2. How to keep an angle of depression**

To keep enough angle of depression  $\theta$  that is an angle between the horizontal and the observer's line of sight (In this case, it is not the observer but an antenna), elevate the antenna height. By making  $\theta$  more than  $5^\circ$ , the blind at the middle and long distances can be avoided. An object below the line of sight cannot be detected.

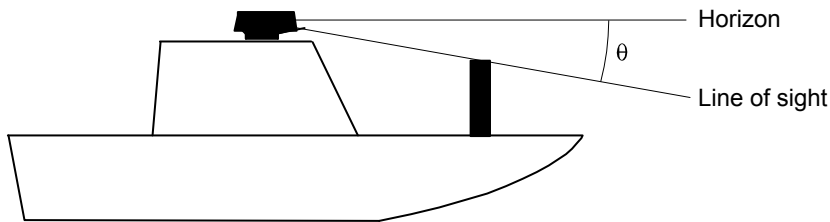

How to keep an angle of depression



### Installation of Antenna

After determining the location of the installation, install the antenna. When installing, if the bracket shown below is available, the installation is easier. If not available, install the antenna directly on the roof, paying attention to the air tube for drain at the bottom of the antenna.

**Note: If the radar mast or installation bracket is warped more than 2mm, make it flat or adjust by inserting spacers.**

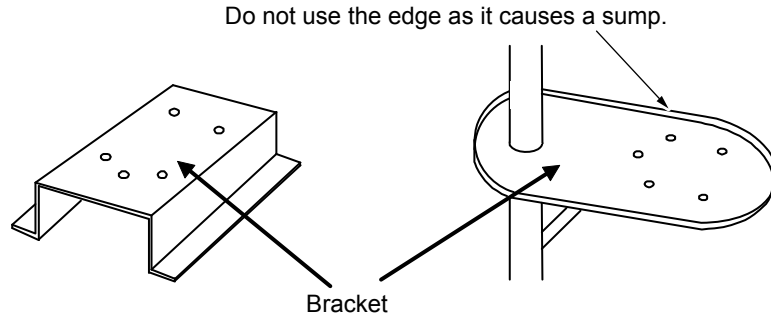

### Installation of Radome Antenna

Referring to the illustration below, make five (5) holes on the cradle and fix the bracket and the antenna together with hexagon bolts. If the thickness of the bracket is 9 to 14mm, it can be installed with the supplied bolts. If not within this range, prepare bolts shown on the table in the next page. To prevent the looseness from occurring, fortify with the commercially available loose-preventive silicon sealing. However, for preventing the looseness of the radome antenna, do not use the putty. The putty may deteriorate chemically the plastic material of the radome.

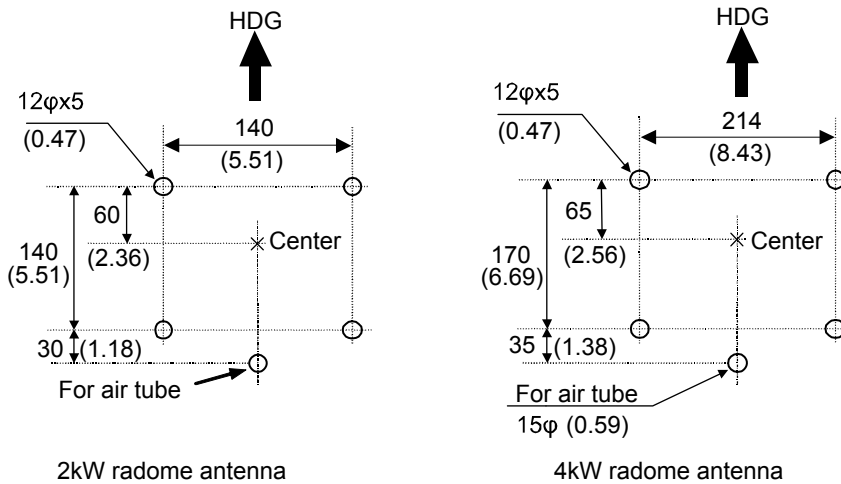

Unit: mm (inch)

Drawing of Work for Installation Holes on the Bracket

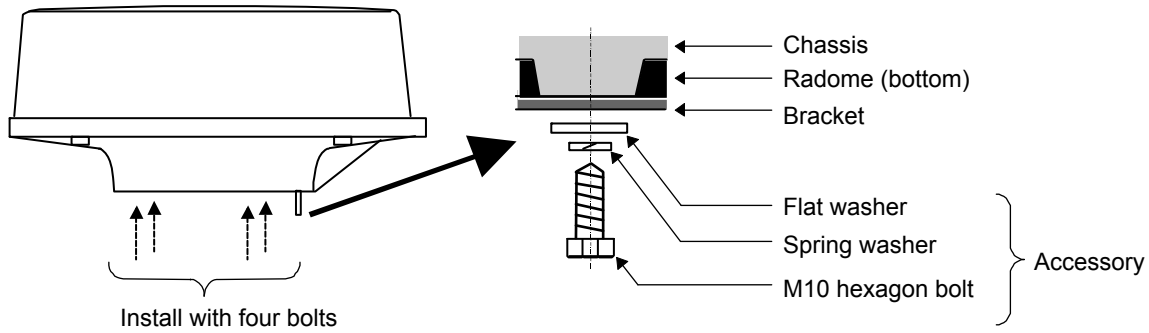

**Specification of bracket thickness-wise installation bolt (In case of Radome antenna)**

Thickness of bracket	Bolt for fixing the antenna	Material	Remarks
4 to 9 mm (0.16 to 0.35 in)	M10x20 (pitch 1.5mm)	stainless	
9 to 14mm (0.35 to 0.55 in)	M10x25 (pitch 1.5mm)	stainless	Included in accessories
14 to 19 mm (0.55 to 0.75in)	M10x30 (pitch 1.5mm)	stainless	

**Setting of Open Antenna**

As illustrated below, install the drive block, facing the cut portion of the installation base toward the stern. This makes it easier to perform the maintenance

1. Referring to the illustration below, make holes of 14mm diameter on the installation side of platform.
2. Place the Scanner unit at the specified position and fix it with four 12mm stainless bolts included in the installation material. If the thickness of the bracket is 9 to 14mm, the bracket can be installed with the supplied bolts. If not within this range, prepare the bolts shown on the table in the next page.

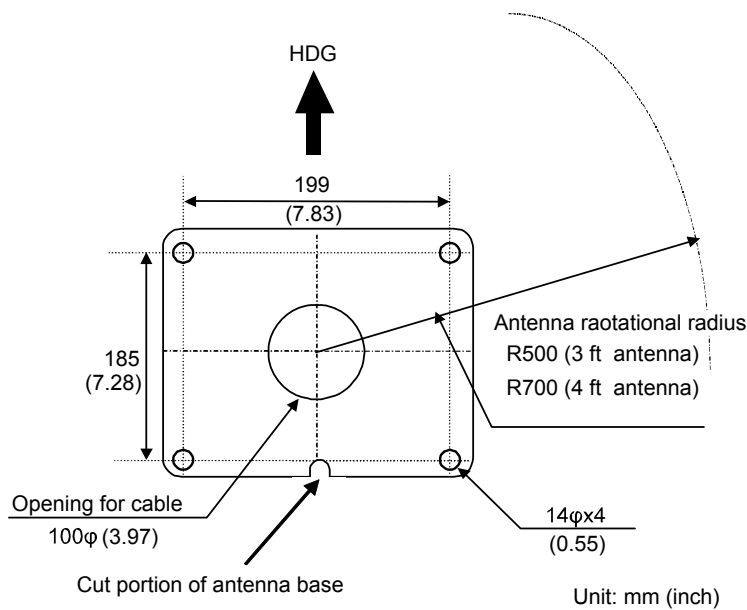

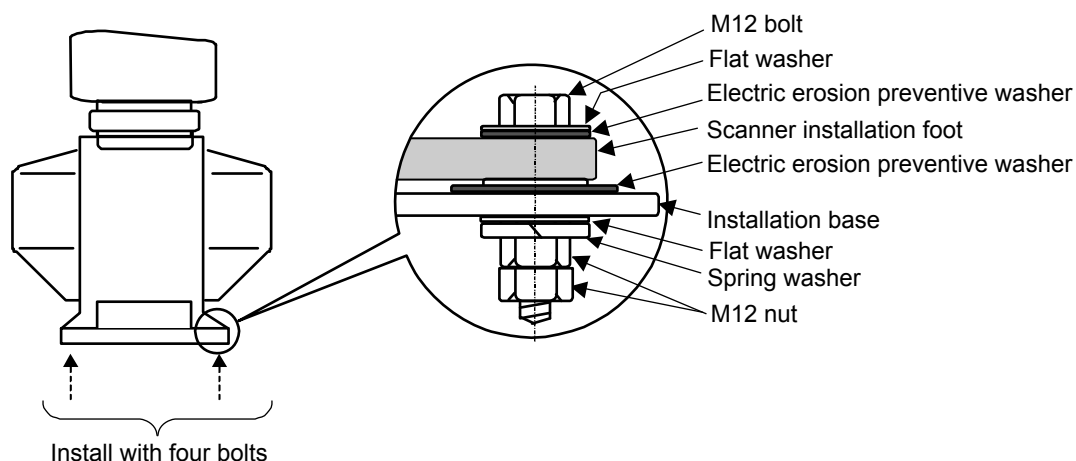

### Specification of bracket thickness-wise installation bolt (In case of open antenna)

Thickness of bracket	Bolt for fixing the antenna	Material	Remarks
4 to 9 mm (0.16 to 0.35 in)	M12x50 (pitch 1.5mm)	stainless	
9 to 14mm (0.35 to 0.55 in)	M12x55 (pitch 1.5mm)	stainless	Included in accessories
14 to 19 mm (0.55 to 0.75in)	M12x60 (pitch 1.5mm)	stainless	

### Installation of Antenna

1. Remove the protective cap covered on the output of the scanner unit rotational shaft.
2. Remove four bolts tentatively fixed to the base of the Antenna and install the Scanner unit to the rotating base. Match the direction of antenna radiation side (KODEN –mark side) with the projection mark on the rotating base.
3. Fix the aerial with four bolts removed in step 2.

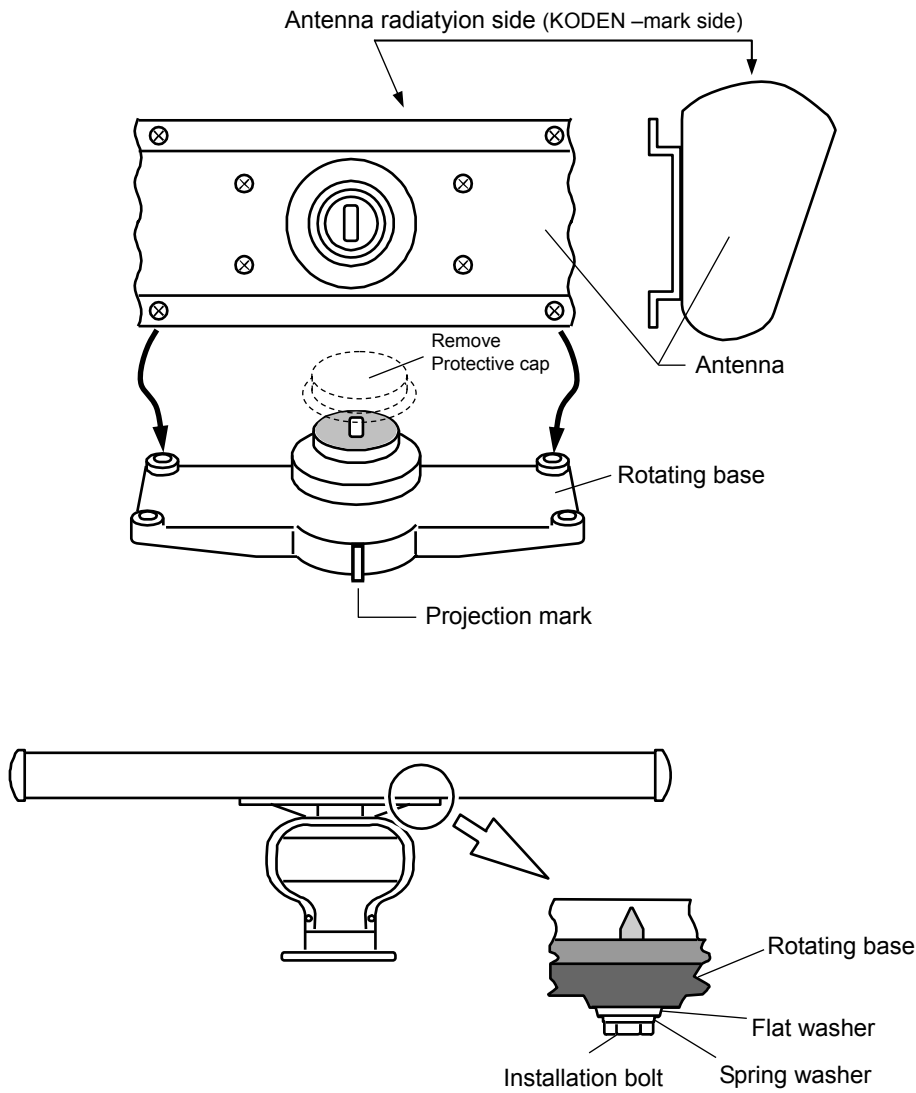

**Cable Connection**

**Radome Antenna (2kW)**

1. Confirm that the power of the scanner unit is turned off. Install the cable to the connector J5 at the rear of the display unit.
2. Next, remove the upper radome of the scanner unit, lifting upward not to touch the aerial inside. (3 pieces of fixing screw)
3. Peel off the tape fixing the aerial.
4. Remove the shield cover at the stern side. (3 pieces of fixing screws)

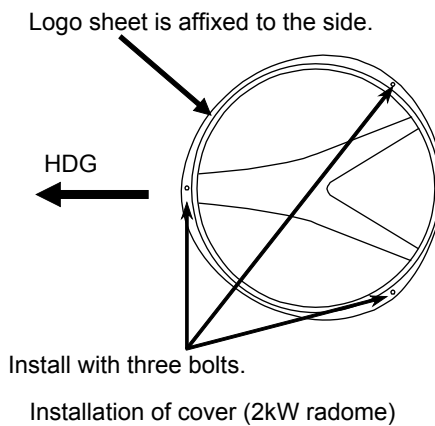

5. Remove the holder plate for fixing the cable and the rubber ring  
Thread the cable through the leading opening  
Insert the rubber ring from both sides of the antenna cable, thread it through the holder plate and fix it to the antenna with the screws.  
Connect the 7-pin connector of the cable to X1 of the printed circuit board.
6. Install the shield cover. At this moment, install the shield of the cable in the groove, using the shield cover. But, be careful for the cable not to be caught by the unit and the cover.
7. Install the upper radome with caution not to touch the radiator.  
Orient the cover as shown in the illustration at the right hand side. 3 markings indicating the screw positions are marked on the upper and lower radomes respectively.  
Install the radome, aligning these markings.

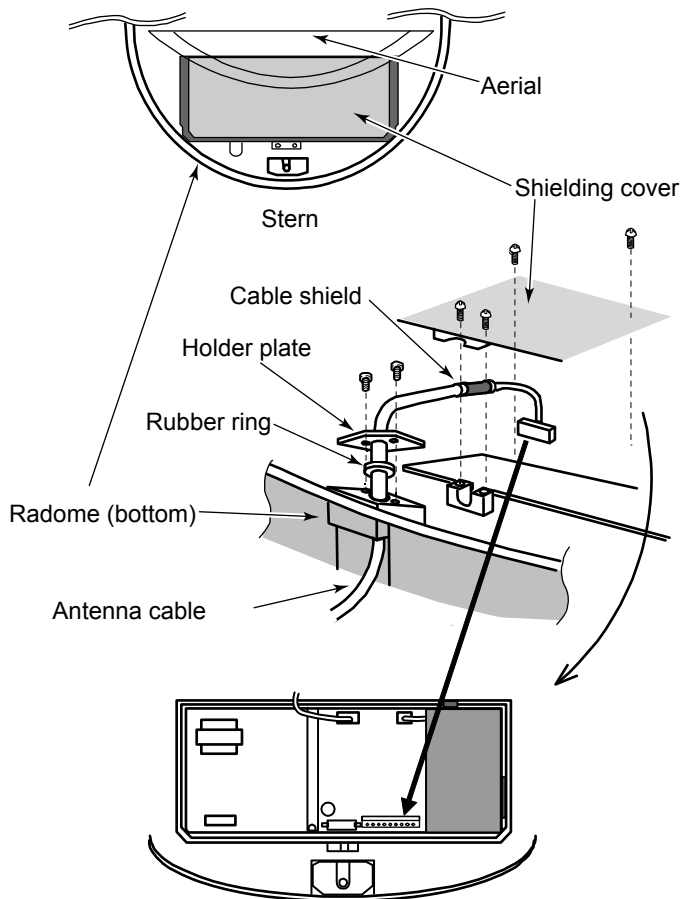

### Radome Antenna (4kW)

1. Confirm that the power of the scanner unit is turned off.  
Install the antenna cable to the connector J5 at the rear of the Display unit.
2. Remove the upper radome of the Scanner unit, lifting upward not to touch the aerial inside. (4 pieces of fixing screw)
3. Peel off the tape fixing the aerial.
4. Remove the shield cover at the stern side. (4 piece of fixing screw)
5. Remove the holder plate for fixing the cable and the rubber ring  
Thread the cable through the leading opening  
Insert the rubber ring from both sides of the scanner unit, thread it through the holder plate and fix it to the aerial with the screws.
6. Connect the 7-pin connector of the cable to X11 of the printed circuit board and the 9-pin connector to X12 respectively.
7. Install the shield cover. At this moment, install the shield of the cable in the groove, using the shield cover. But, be careful for the cable not to be caught by the unit and the cover.

8. Install the upper radome with caution not to touch the aerial. Orient the cover as shown in the illustration below. 4 markings indicating the screw positions are marked on the upper and lower radomes respectively. Install the radome, aligning these markings.

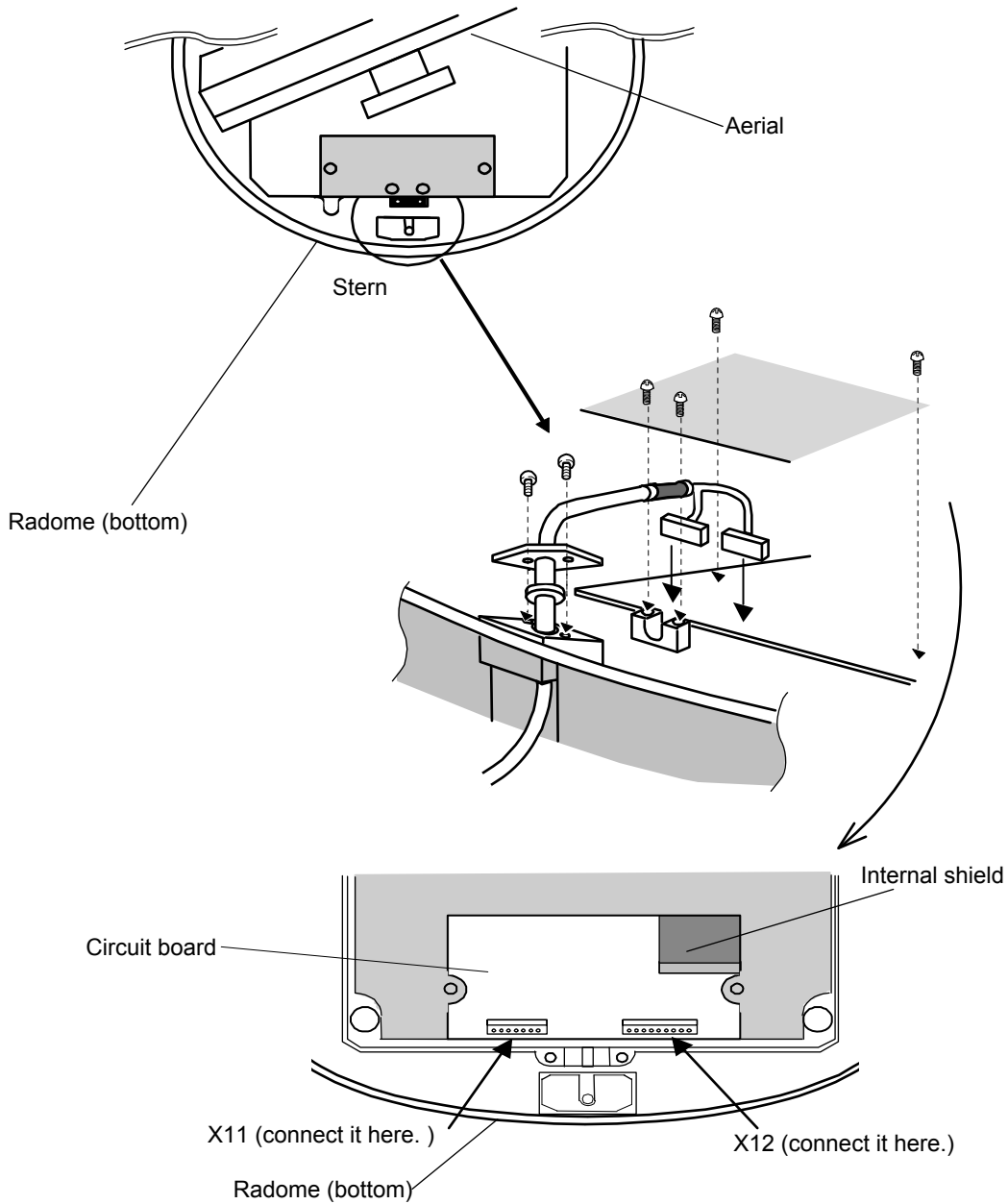

Installation of 4kW radome antenna cable

**Open Antenna (4kW)**

1. Please make sure power supply of the Scanner unit is OFF.
2. Disassemble the front cover of the Scanner unit from the rear cover by loosening fixing bolts.
3. Remove the TR unit by disconnecting the connector X1 and X2 after loosening fixing bolts of the TR unit. Please make sure magnetron does NOT touch metals.
4. Remove the cable holder plate and the rubber packing by loosening bolts at the bottom of the Scanner unit box.
5. Antenna cable shall be taken into the Scanner unit box through the cable inlet hole.
6. Antenna cable shall be fixed as described in the illustration below, using the cable holder plate and the rubber packing removed in 4. Shield braid terminal shall be fixed under the cable holder plate together with lug terminal, after removing the edge portion of heat contraction tube of the antenna cable.
7. Mount the TR unit after connecting the X1 and X2 connectors (removed in 3) by fixing bolts.
8. 7 pin connector shall be connected to X11 of the TR unit, 9 pin connector to X12.
9. Antenna cable shall be clamped onto the TR unit. Please make sure the antenna cable does NOT touch magnetron lead wires.
10. The front and rear covers of the Scanner unit shall be fixed by fixing bolts.

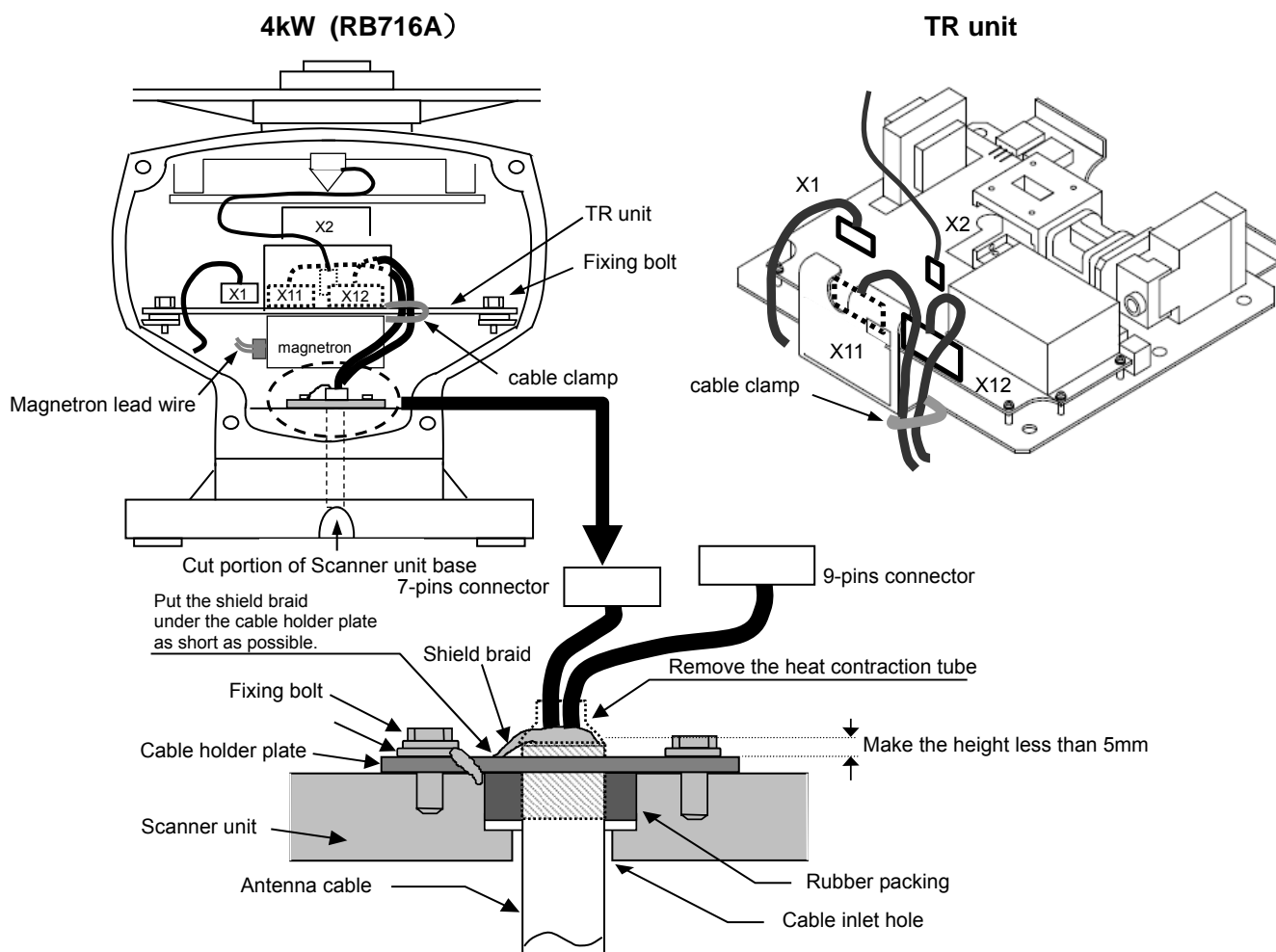

## 5.2 Mutual Connection Diagram

### 2kW Radome Antenna (RB714A)

Antenna

Remark	Color of lead wire	No.
+250V	Violet	1
+24V	Blue	2
+12V	Orange (wide cable)	3
GND	Yellow	4
DATA	Red	5
DATA-RTN	Shield	6
BP/SHF	Brown	7
BP/SHF-R	Shield	8
V/TRIG	Gray (coaxial cable)	9
V/TRIG-RTN	Shield	10

GND Terminal

GND	Shield	1
-----	--------	---

Display Unit

No.	Color of lead wire	Remark
1	Violet	+250V
2	Blue	+24V
3	Orange (wide cable)	+12V
4	Yellow	GND
5	Shield	DATA-RTN
6	Red	DATA
7	-	NC
8	Brown	BP/SHF
9	Shield	BP/SHF-RTN
10	Gray (coaxial cable)	V/TRIG
11	-	NC
12	-	NC
13	-	NC
14	Shield	V/TRIG-RTN
15	-	NC
16	-	NC

### 4kW Radome Antenna /4kW Open Antenna (RB715A/RB716A)

Antenna

Remark	Color of lead wire	No.
+250V	Violet	1
NC	-	2
GND	Yellow	3
SHIP'S+	Red (wide cable)	4
SHIP'S+	Yellow (wide cable)	5
SHIP'S-	Green (wide cable)	6
SHIP'S-	Blue (wide cable)	7

Remark	Color of lead wire	No.
+24V	Blue	1
NC	-	2
+12V	Orange (wide cable)	3
DATA-RTN	Shield	4
DATA	Red	5
BP/SHF-R	Shield	6
BP/SHF	Brown	7
V/TRIG-RTN	Shield	8
V/TRIG	Gray (coaxial cable)	9

GND terminal

GND	Shield	1
-----	--------	---

Display Unit

No.	Color of lead wire	Remark
1	Violet	+250V
2	Blue	+24V
3	Orange (wide cable)	+12V
4	Yellow	GND
5	Shield	DATA-RTN
6	Red	DATA
7	-	-
8	Brown	BP/SHF
9	Shield	BP/SHF-RTN
10	Gray (coaxial cable)	V/TRIG
11	-	-
12	Red (wide cable)	SHIP'S+
13	Yellow (wide cable)	SHIP'S+
14	Shield	V/TRIG-RTN
15	Green (wide cable)	SHIP'S-
16	Blue (wide cable)	SHIP'S-



### 5.3 Display Unit Installation

The display unit can be installed on the desktop or as flush mount.

Please install the display unit to the following procedure.

In addition, please install the display unit securing safety distance from the magnetic compass.

#### Safety Distance from Magnetic Compass

Standard Compass	Steering Compass
1.1m	0.5m

#### Desktop Installation

1. Remove two knob bolts fixing the display unit to the bracket.
2. Remove the display unit from the bracket and place it on the stable flat place.
3. Place the bracket on the position where the display unit will be installed and fix the bracket with five 5mm screws.
4. Place the display unit on the installation bracket and fix the display unit with two knob bolts removed in step 1.

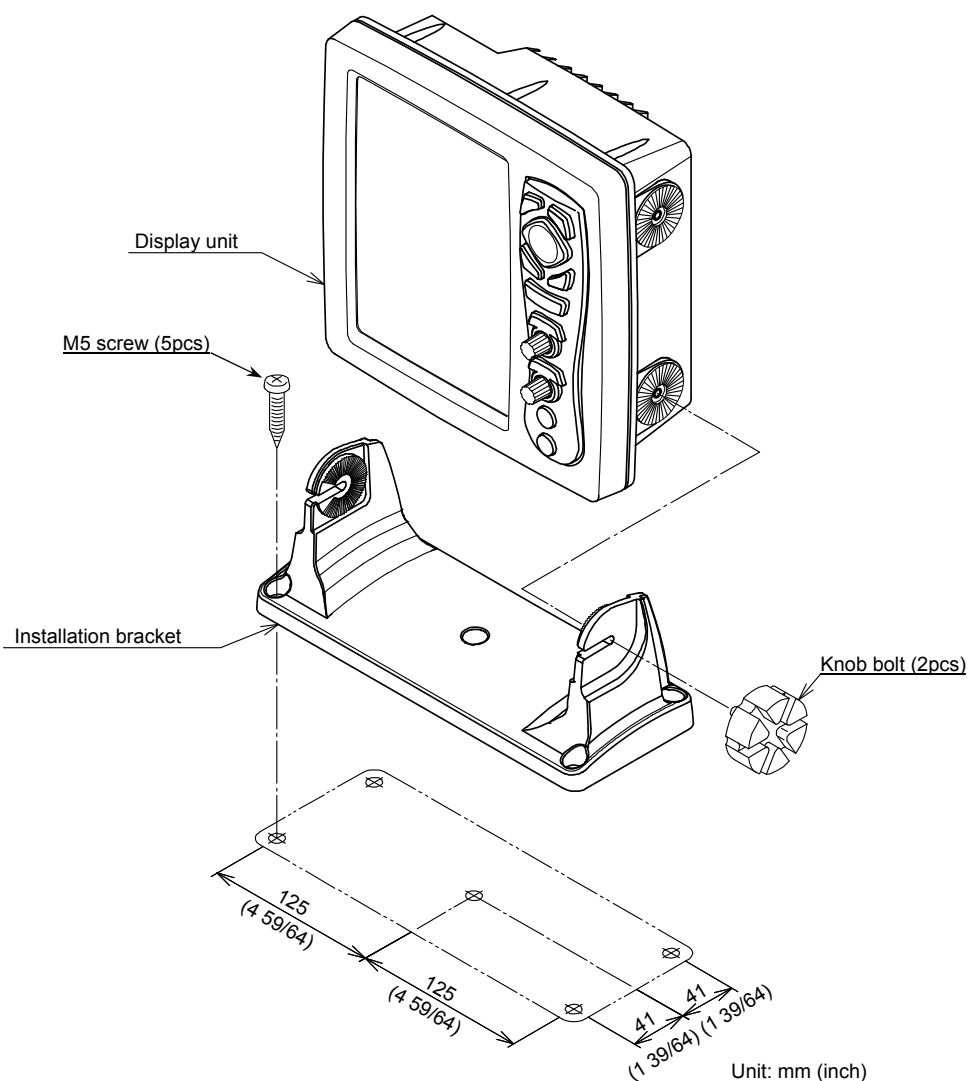

**Caution:** When installing on the desktop, the maintenance space shown in the illustration below is required for cable lay-out, plugging-in/out of connector, fuse replacement and bolt tightening.

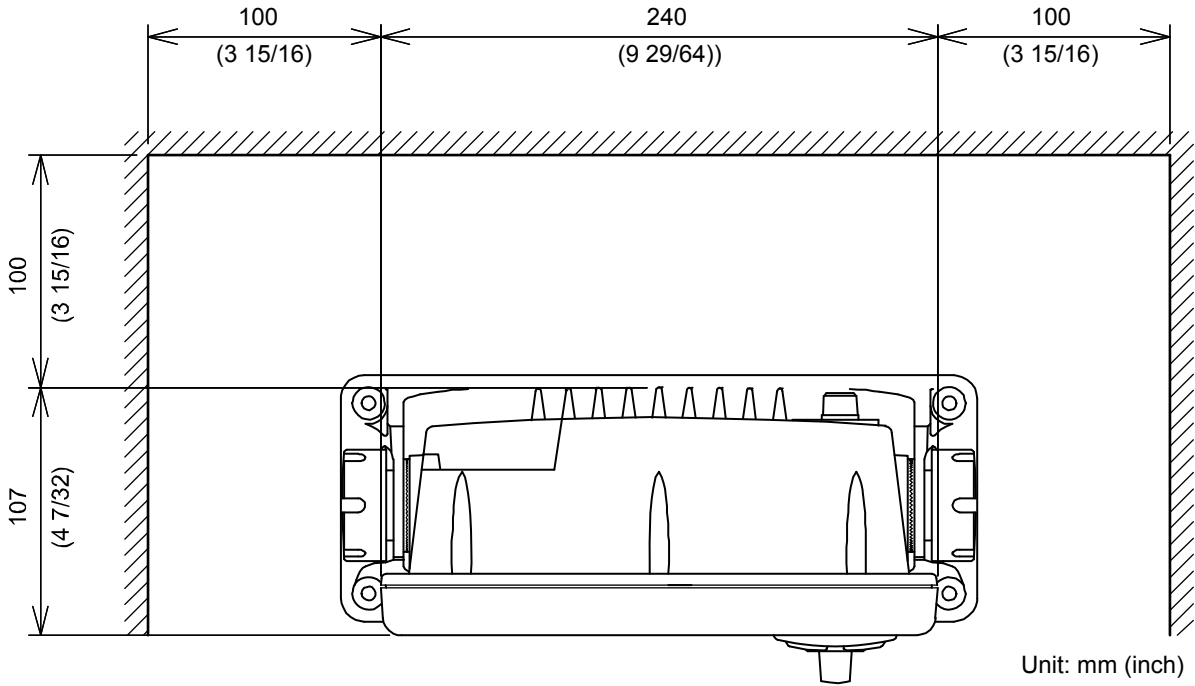

### Flush-mount Installation

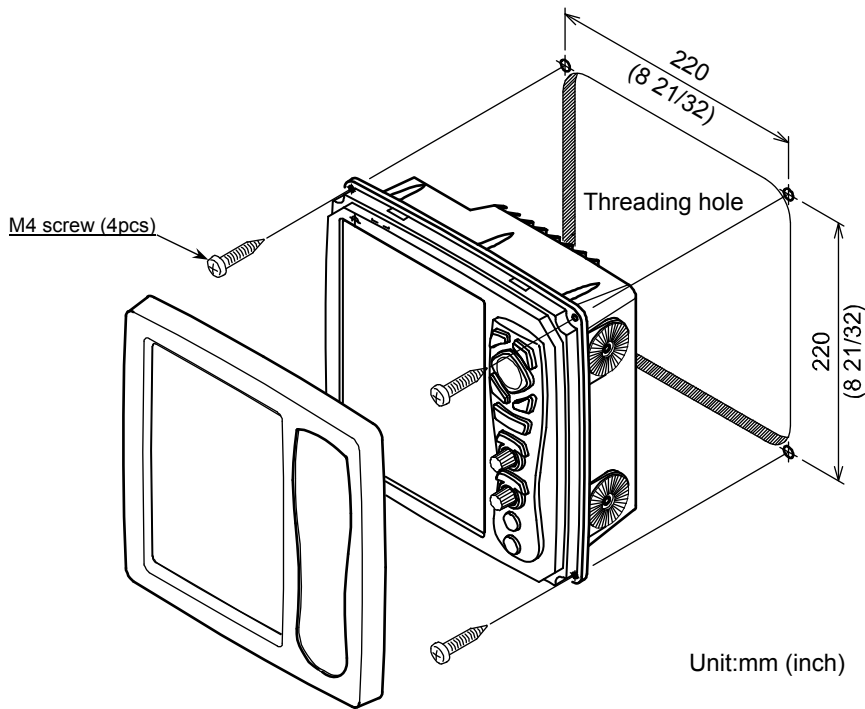

1. Make a square hole of 220x220 (depth x width) on the installation place. (See the illustration below.)

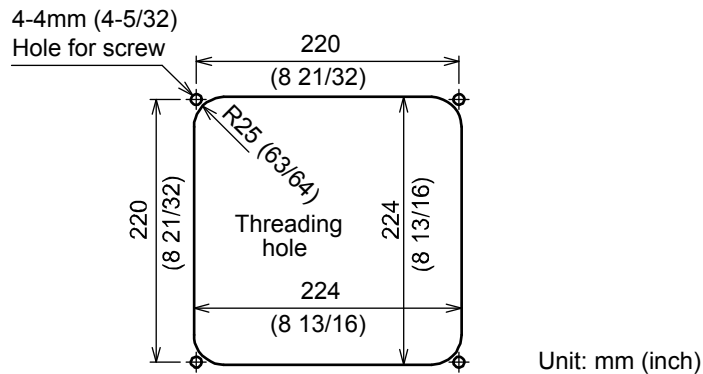

2. Turn counterclockwise the knob bolt fixing the display unit to the installation bracket to loosen and lift the display unit upward. The bracket and the knob are no longer used.
3. Confirm that the display unit fits the square hole by mating them. If not fit, correct the square hole.
4. Insert a coin in the gap at the lower part of the display unit and remove the front frame. (Refer to the illustration below.)

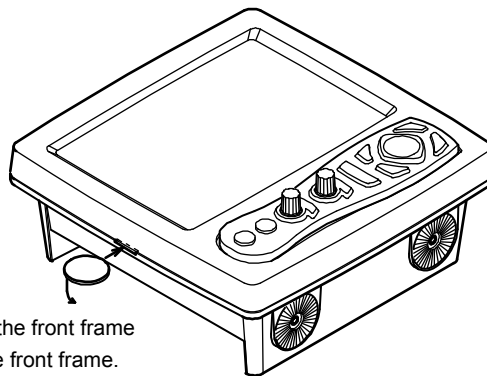

Insert a coin and remove the front frame by depressing to lift up the front frame.

5. Connect all of the connectors for power, antenna and others to the main unit.
6. Insert the indicator in the place (square hole) and fix it with four pieces of 4mm tapping screw (or M4 pan-head screws). (Prepare 4mm screws suited for thickness of the installation part.)
7. Install the front frame removed in step 4.

## 5.4 Adjustment after Installation

Before setup, confirm the following points to operate properly the equipment

1. The ship's power, to which the radar system is connected, should be the specified voltage.
2. No person should be present around the antenna and mast. The display unit should bear the placard, describing the caution [Radar being adjusted, do not touch the operating block.]

After confirming the above items, be sure to perform the adjustments.  
 The adjustments after the installation are the following items in 3.3 Setup of Adjustment Items.

- BRG ADJ
- TX DELAY ADJ
- MBS
- AUTO TUNE ADJ

## 5.5 Wiring

### Cable connection to the Display unit

Connect the power cable, antenna cable and cables of others to specified connectors of the display unit. If optional navigation equipment and CCD camera are provided, connect also the cables of these equipments.

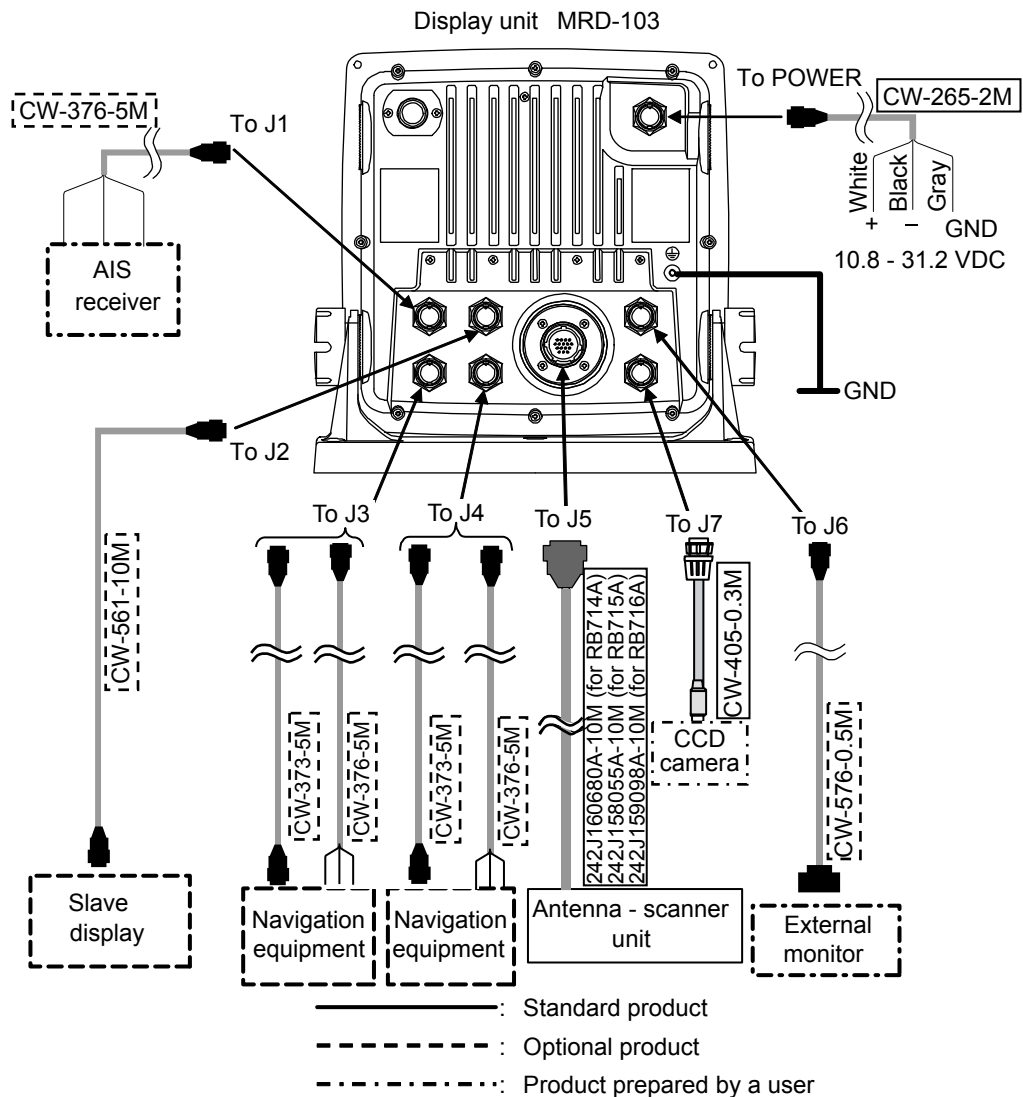

\* Be sure to connect the GPS compass to J4.

### Pin Assignment of Rear Connector

The pin assignment is viewed from the rear of the display unit.

#### AIS Input

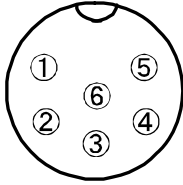

**J1**

- ① GND
- ② Un-connected
- ③ Un-connected
- ④ AISIN+
- ⑤ AISIN-
- ⑥ Un-connected

#### Slave display

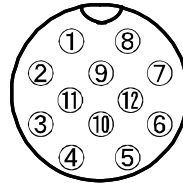

**J2**

- ① Video output
- ② Trigger output
- ③ GND
- ④ Azimuth output
- ⑤ Heading line output
- ⑥ GND
- ⑦ Video signal input
- ⑧ Trigger input
- ⑨ GND
- ⑩ Azimuth input
- ⑪ Heading line input
- ⑫ +12V output

#### NMEA/IEC61162 Input/Output

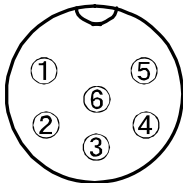

**J3**

- ① GND
- ② NMEA TX+
- ③ NMEA TX-
- ④ NMEA RX+
- ⑤ NMEA RX-
- ⑥ +12V output

#### NMEA/IEC61162 Input/Output

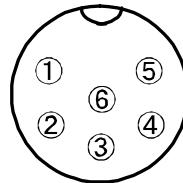

**J4**

- ① GND
- ② NMEA TX+
- ③ NMEA TX-
- ④ NMEA RX+
- ⑤ NMEA RX-
- ⑥ Un-connected

#### Antenna-scanner unit

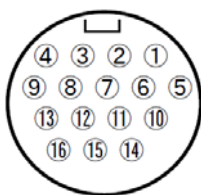

**J5**

- ① +250V
- ② +24V
- ③ +12V
- ④ GND
- ⑤ DAT-R
- ⑥ DAT
- ⑦ Un-connected
- ⑧ BP/SHF
- ⑨ BP/SHF-R
- ⑩ V/TRIG
- ⑪ Un-connected
- ⑫ SHIP'S+
- ⑬ SHIP'S+
- ⑭ V/TRIG-R
- ⑮ SHIP'S-
- ⑯ SHIP'S-

#### External monitor/External buzzer

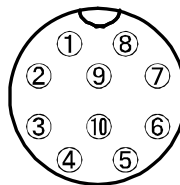

**J6**

- ① R
- ② R-GND
- ③ G
- ④ G-GND
- ⑤ B
- ⑥ B-GND
- ⑦ H-SYNC
- ⑧ V-SYNC
- ⑨ External buzzer+
- ⑩ External buzzer-

#### CCD camera Input

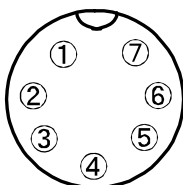

**J7**

- ① Camera1 input
- ② Camera1 GND
- ③ Not-used
- ④ Not-used
- ⑤ Not-used
- ⑥ Not-used
- ⑦ Not-used

#### Power Input

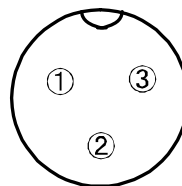

**POWER**

- ① POWER-
- ② POWER+
- ③ GND

### Connection of DC power cable (CW-265-2M)

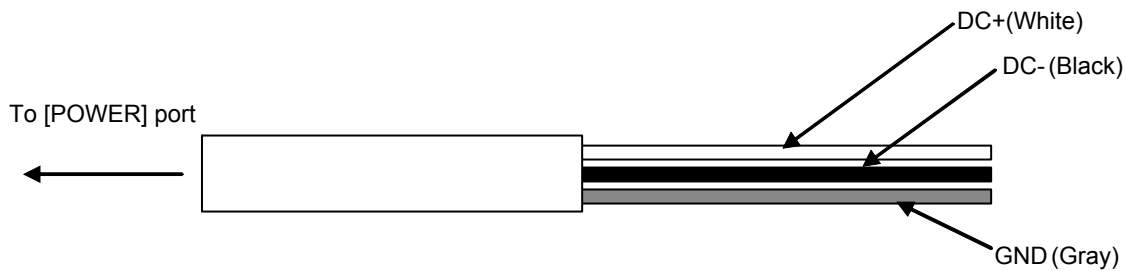

### Grounding

- Use the large diameter cable for ground wire as possible.
- Connect the ground wire to the ground material at a shortest distance.
- When connecting the external equipment whose positive polarity is connected to the ground line, do not connect the ground of the signal line to the cabinet ground.

### Connection with the AIS Receiver (J1) (Prepared by a customer)

Use the CW-376-5M (Optional) when installing the AIS receiver. For connecting any equipment, one end of the CW-376-5M is left un-treated. Prepare a connector suitable for the equipment you desire to connect.

The connection cable (CW-376-5M) consists of six core wires and the shield wire around them. A signal is inputted from the orange (AISIN+) and black (AISIN-) wires.

For the CW-376-5M and connector for connection of AIS receiver, refer to the illustration below.

After soldering, perform the waterproof and insulation treatment on the junction with a self-fusion tape.

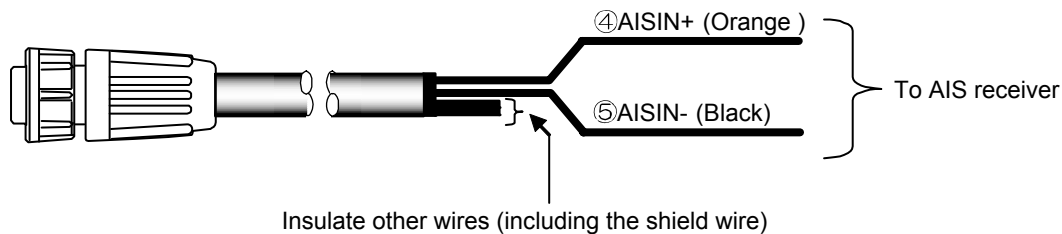

### Connection with the navigation equipment (J3, J4)

Two NMEA0183/IEC61162 input/output ports are provided. Connect the navigation equipment and the external equipment such as KODEN made GPS sensor to them. The optional cable with connectors at both ends is available. The CW-376-5M of which one end is left untreated is also available. Prepare a cable suitable for the equipment you desire to connect.

The connection cable CW-376-5M consists of six core wires and the shield wire around them. A signal is outputted from the white (NMEA TX+) and red (NMEA TX-) wires, and a signal is inputted from the orange (NMEA RX+) and black (NMEA RX-) wires.

For wiring of CW-376-5M, refer to the illustration below.

#### Structure of CW-376-5M

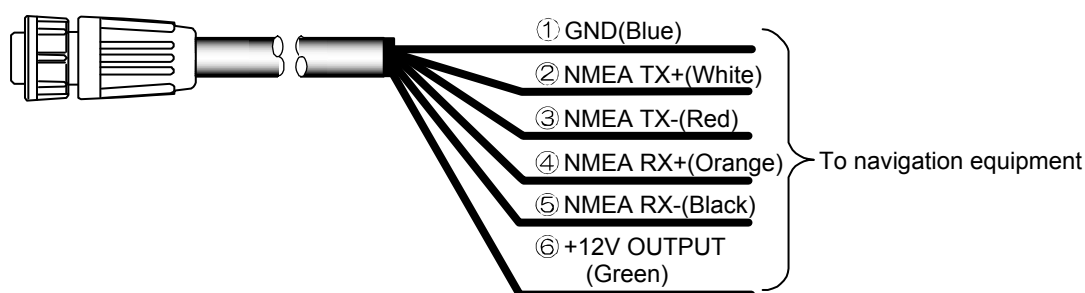

\* In only J3, +12V is outputted

**Caution:** Insulate the un-used lead wires by winding them with an insulation tape not to contact each other.

### Connection of External Buzzer and External Monitor (J6) (Prepared by a customer)

When installing an external buzzer or external monitor (VGA monitor, analog RGB input), connect it via CW-576-0.5M. For its wiring, refer to the illustration below.

After soldering, perform the waterproof and insulation treatment on the junction with a self-fusion tape.

**Note:** For the rated voltage of the buzzer, use the same DC voltage of the ship's power supply to which the radar display unit is connected.

#### Structure of CW-576-0.5M

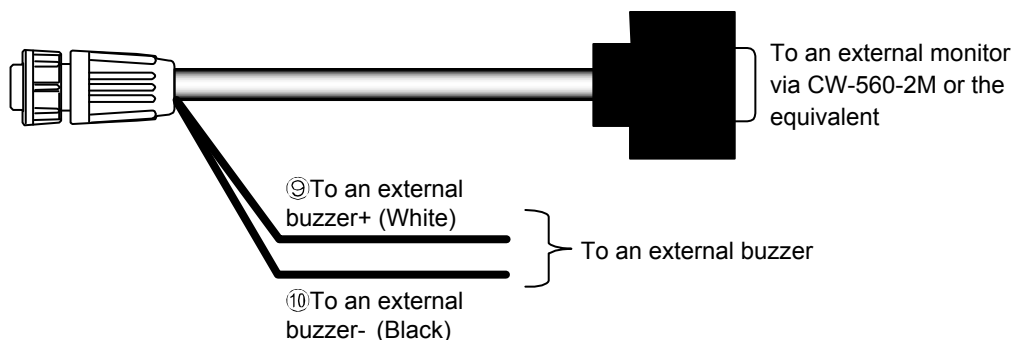

### Connection of CCD Camera (J7) (Prepared by a customer)

The standard product CW-405-0.3M is equipped with a RCA jack for connection to the CCD camera (NTSC/PAL/SECAM). Connect the video output terminal (RCA plug (In most cases, yellow)) of your CCD camera. Perform the waterproof treatment on the junction of the RCA terminal with a self-fusion tape.

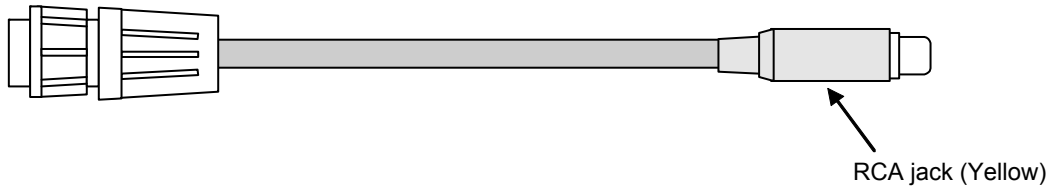

## 5.6 List of Input/Output Sentence

### Input Sentence

The sentences shown on the table below can be received.  
In NMEA0183 versions 1.5, 2.0 and 3.0, inputting is possible.

Information	Priority of Sentence
Latitude/Longitude	GGA > RMC > RMA > GNS > GLL
Heading	HDT > HDG > HDM > VHW > RMC > RMA > VTG
Ship speed	RMC > RMA > VTG > VHW
WPT	BEC > BWC > BWR > RMB
Cross Track Error	RMB > XTE
Wind direction	MWV > MWD
Wind speed	MWV > MWD
Water depth	DPT > DBT
Water temperature	MTW

### Output Sentence

The TTM and TLL sentences can be transmitted.  
Outputting is performed in NMEA0183 version 2.0.

Sentence	Information
TTM*	Target Information
TLL**	Target Position

\* To output the TTM sentence, install the ATA board (optional) and heading bearing data and ship's speed data are required.

\*\* To output the TLL sentence, the GPS sensor (optional) is required.



## Chapter 6 Attached Table

## 6.1 Menu Configuration

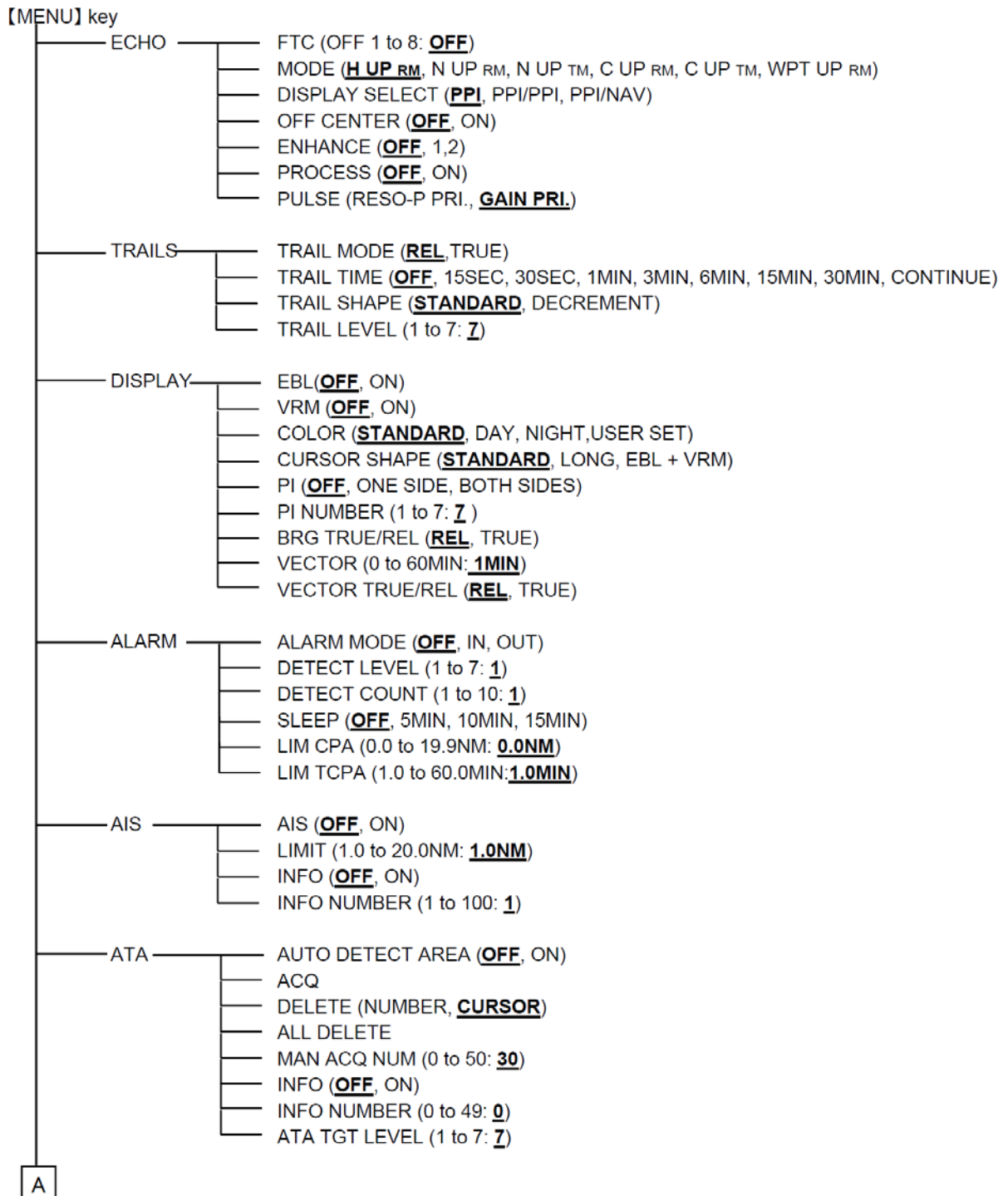

A		
	ASSIST	<ul style="list-style-type: none"> <li>— RANGE RINGS (<b>OFF</b>, ON)</li> <li>— RANGE UNIT (<b>NM</b>, km, sm)</li> <li>— SPPED UNIT (<b>kn</b>, km/h, m/h)</li> <li>— TEMP UNIT (<b>°C</b>, °F)</li> <li>— DEPTH UNIT (<b>m</b>, fm, l. fm, ft, J.fm)</li> <li>— POSITION DISPLAY (OFF, <b>OWN Position</b>, WPT Position, POB Position)</li> <li>— WPT DISPLAY (OFF, <b>ON</b>)</li> <li>— ROTATION SPEED (STANDARD, <b>HIGH SPEED</b>)</li> <li>— ALL PPI (OFF, <b>ON</b>)</li> <li>— GUIDE (OFF, <b>ON</b>)</li> <li>— BUZZER (OFF, <b>ON</b>)</li> <li>— MOTOR SPEED (<b>OFF</b>, ON)</li> <li>— N UP/S UP (<b>NUP</b>, S UP)</li> <li>— CURSOR DISPLAY (<b>ALWAYS</b>, OPERATING)</li> <li>— SET STATUS DISP (OFF, <b>ON</b>)</li> <li>— MENU OPERATE (<b>A</b>, B)</li> </ul>
	ADJUST	<ul style="list-style-type: none"> <li>— BRG ADJ (-180 to +180.0: <b>0.0</b>)</li> <li>— TX DELAY ADJ (0 to 255: <b>20</b>)</li> <li>— MBS (0 to 100: <b>20</b>)</li> <li>— STC CURVE (1 to 8: <b>4</b>)</li> <li>— TUNE SELECT (<b>AUTO</b>, MANUAL)</li> <li>— AUTO TUNE ADJ (0 to 100: <b>31</b>)</li> <li>— MANUAL TUNE ADJ (0.0 to 100: <b>44.0</b>)</li> <li>— PULSE WIDTH (SP, M1, M2, L1, L2) [RANGE 0.75 to 8 Set individually.]</li> <li>— IR (OFF, 1, <b>2</b>)</li> <li>— ECHO COLOR DIV (<b>STANDARD</b>, DETAIL)</li> <li>— SIGNAL SELECT (<b>ANTENNA</b>, MONITOR, DEMO)</li> <li>— FIELD OF ANGLE (0 to 50 : <b>0</b>)</li> </ul>
	NMEA	<ul style="list-style-type: none"> <li>— CH1 (J3) (<b>4800</b>, 9600, 19200, 38400)</li> <li>— CH2 (J4) (<b>4800</b>, 9600, 19200, 38400)</li> <li>— KGC-1 SETTING</li> </ul>
	PRESET	<ul style="list-style-type: none"> <li>— F1 KEY SET (FTC,MODE, DISPLAY SELECT, OFF CENTOR, ENHANCE, TRAIL TIME, <b>EBL</b>, VRM, COLOR, PI, ALARM MODE, ACQ, DELATE, POB, TARGET, OTHER SHIP, PULSE,PROCESS)</li> <li>— F2 KEY SET (SAME AS F1 KEY: <b>VRM</b>)</li> <li>— SELECT RANGE S (OFF, ON[RANGE 0.0625 to 1.5])</li> <li>— SELECT RANGE M (OFF, ON[RANGE 2 to 16])</li> <li>— SELECT RANGE L (OFF, ON[RANGE 24 to 48])  <ul style="list-style-type: none"> <li>— The maximum range differs depending on type of antenna.</li> </ul> </li> <li>— ECHO COLOR (BACK, ECHO COLOR 1 to 7)</li> <li>— TRAIL COLOR (TRAIL COLOR 1 to 7)</li> <li>— DISPLAY COLOR (CURSOR, CHARACTER, STRING EDGE, AIS/ATA)</li> <li>— LANGUAGE (ENGLISH, JAPANESE, OTHERS)</li> <li>— NAV SELECT (<b>WPT</b>, DEPTH/TEMP, WIND,COMPASS, AIS LIST, ATA LIST)</li> <li>— CAMERA POSITION (-25 to +25: <b>0</b>)</li> </ul>
	MAINTE	<ul style="list-style-type: none"> <li>— DISPLAY UNIT</li> <li>— ANTENNA</li> <li>— PANEL TEST</li> <li>— LCD TEST</li> <li>— OPE HOURS RESET</li> <li>— TX HOURS RESET</li> <li>— ALL RESET</li> <li>— SYS PRG LOAD</li> </ul>

## 6.2 Specifications

Specification item	Content		
Model	MDC-921	MDC-941	MDC-940
<b>Antenna-scanner unit</b>			
Antenna type	Radome (RB714A)	Radome (RB715A)	Open array (RB716A)
Antenna length	1.2 feet	2 feet	3 feet    4 feet
Output power (Peak)	2 kW	4 kW	4 kW
Output frequency	9445 MHz +/- 30 MHz	9410 MHz +/- 30 MHz	9410 MHz +/- 30 MHz
Horizontal beam width	6.0°	3.9°	2.5°    1.8°
Vertical beam width	25°		22°
Rotation	24 rpm	24 rpm or 48 rpm	24 rpm or 48 rpm (48 rpm:24VDC or more)
IF center frequency	60 MHz		
Minimum detecting distance	Within 30 m	Within 25 m	Within 25 m
Range resolution	Within 30 m	Within 25 m	Within 25 m
Warm-up time	2 min		
Pulse width	0.1 us, 0.15 us, 0.3 us, 0.5 us, 1 us		
<b>Display unit (MRD-103)</b>			
Display size and type	8.4 inch color TFT LCD Display VGA		
Effective diameter	127.4 mm		
Display resolution	480 x 640 pixels		
Off-centering	Maximum up to 66%		
Echo area	2 types (Full screen, Inside of effective diameter)		
Distance accuracy	8 m or 1% of range		
Bearing accuracy	1° or less		
Basic Range	0.0625 to 24NM	0.0625 to 32NM	0.0625 to 48NM
Range scales	0.0625, 0.125, 0.25, 0.5, 0.75, 1, 1.5, 2, 3, 4, 6, 8, 12, 16, 24, 32 and 48 NM (MDC-921 up to 24NM, MDC-941 up to 32NM, MDC-940 up to 48 NM)		
Range interval	0.03125(0.0625), 0.0625(0.125), 0.125(0.25, 0.5), 0.25(0.75, 1), 0.5(1.5, 2), 0.75(3), 1(4), 1.5(6), 2(8), 3(12), 4(16), 6(24), 8(32), 12(48) ( ):Range scales		
Presentation modes	Head-up, North-up*, Course-up*, WPT-up**		
Indication system	PPI, PPI/PPI, PPI/NAV		
Video levels	8 levels (Colors)		
Distance unit (VRM UNIT)	NM, sm, km		
Alarms	In or OUT		
Functions	Interference rejection, Target expansion, VRM, EBL, Parallel index, Cursor position (Lat/Lon), Bearing (true/relative), Trail*, RGB Monitor output, Slave display monitor input/output, External Buzzer, Accepts CCD camera input, Dual display		
AIS interface***	100 targets (Option)		
ATA***	50 targets (Option)		

<b>Input/output</b>			
NMEA input/output	2		
Input data format and sentences	NMEA0183 (BEC, BWC, BWR, DPT, DBT, GGA, GLL, GNS, HDG, HDM, HDT, MTW, MWD, MWV, RMA, RMB, RMC, VHW, VTG, XTE)		
Output data format and sentence	NMEA0183 (TTM, TLL)		
Power supply	10.8 to 31.2 VDC		
Power Consumption (at 24VDC)	45 W or less	55 W or less	70 W or less
<b>Environmental</b>			
Operating temperature	-15°C to +55°C (Display unit)		-25°C to +55°C (Antenna-scanner unit)
Store temperature	-30°C to +70°C (Display unit)		-40°C to +85°C (Antenna-scanner unit)
Upper limit of humidity	93% +/- 3% (at +40°C)		
Water Protection	IPX5 (Display Unit) CFR-46 (RB714A) IPX6 (RB715A, RB716A)		
Vibration Resistant	When the following vibration is applied to equipment respectively under specified condition, its performance should not be affected. <ul style="list-style-type: none"> <li>• From 2 - 5Hz up to 13.2Hz vibration width +/- 1mm +/- 10% (Maximum acceleration 7m/s<sup>2</sup> constant at 13.2Hz)</li> <li>• From 13.2Hz up to 60Hz Maximum acceleration 7m/s<sup>2</sup> constant</li> </ul>		
Dimension of equipment	Maximum 274 x 263 x 133 mm (Main unit 240 x 240 x 112 mm)		
Weight	3.7kg		

\* Requires heading, speed, and/or position signal input from external equipment including GPS Compass depending on application of user.

\*\* Requires waypoint data input.

\*\*\* For true trail, entering the bearing data, ship's speed data and latitude/longitude are required.

**6.3 External View**

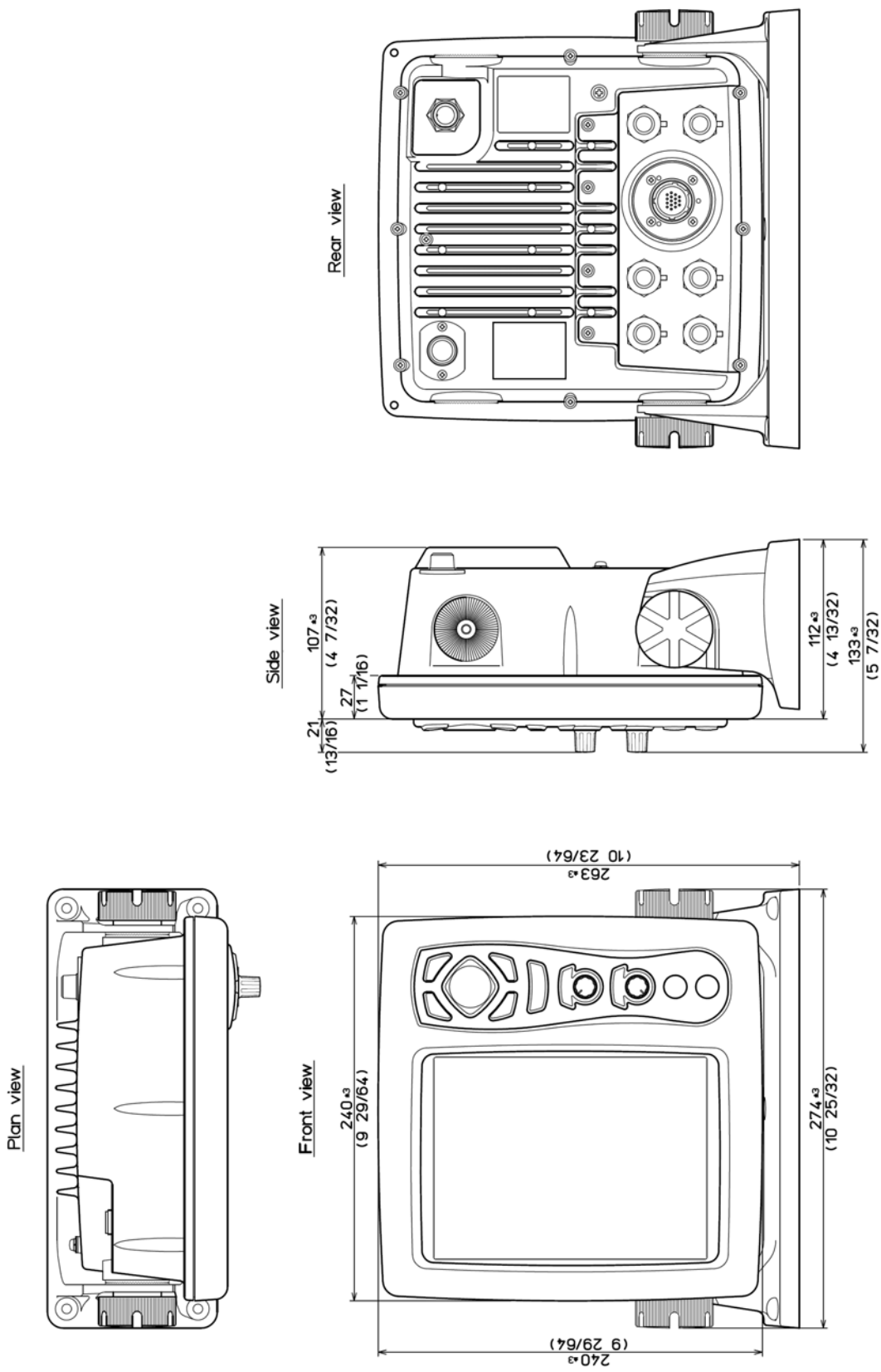

Unit: mm (inch)

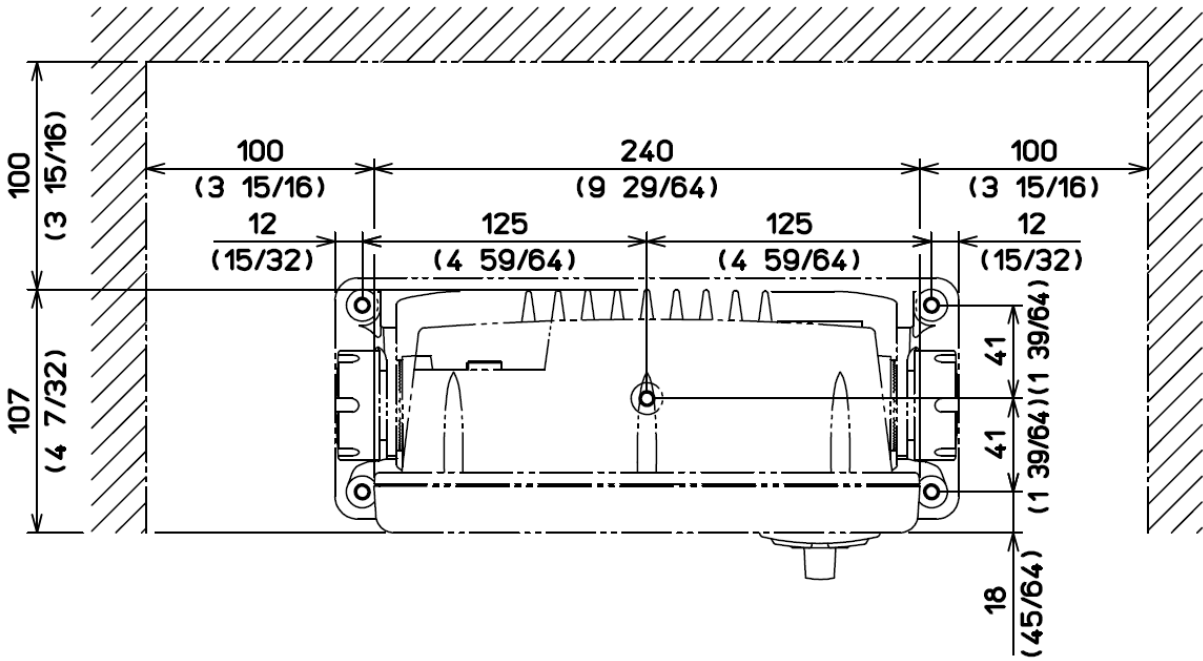

Dimension drawing of table installation

Unit: mm (inch)

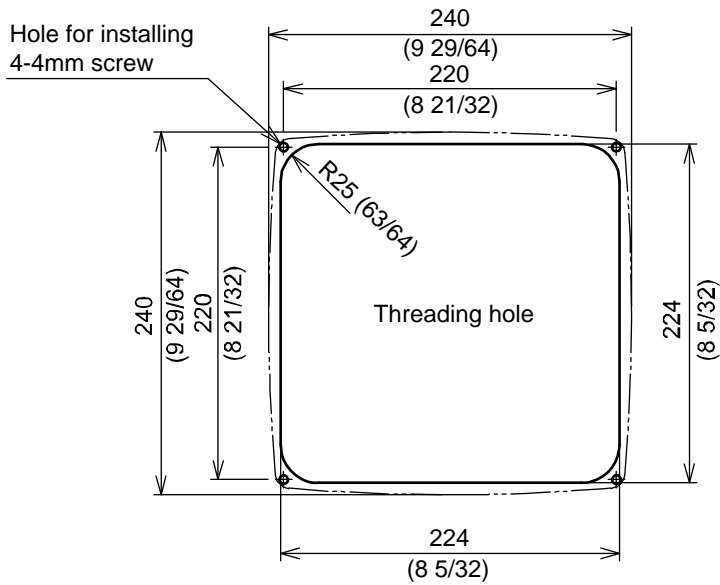

Unit: mm (inch)

Dimension drawing of flush-mount installation

RB714A

Unit: mm (inch)

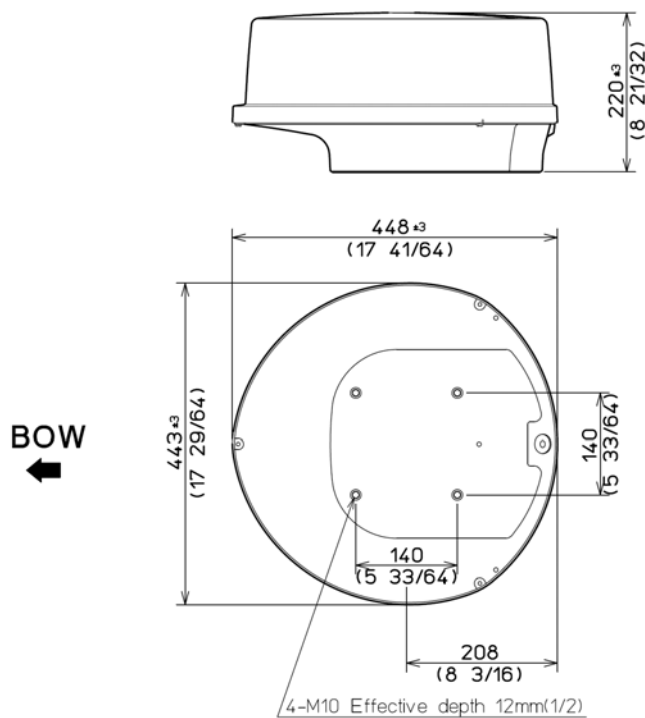

Weight: 6kg (13.5lb)

RB715A

Unit: mm (inch)

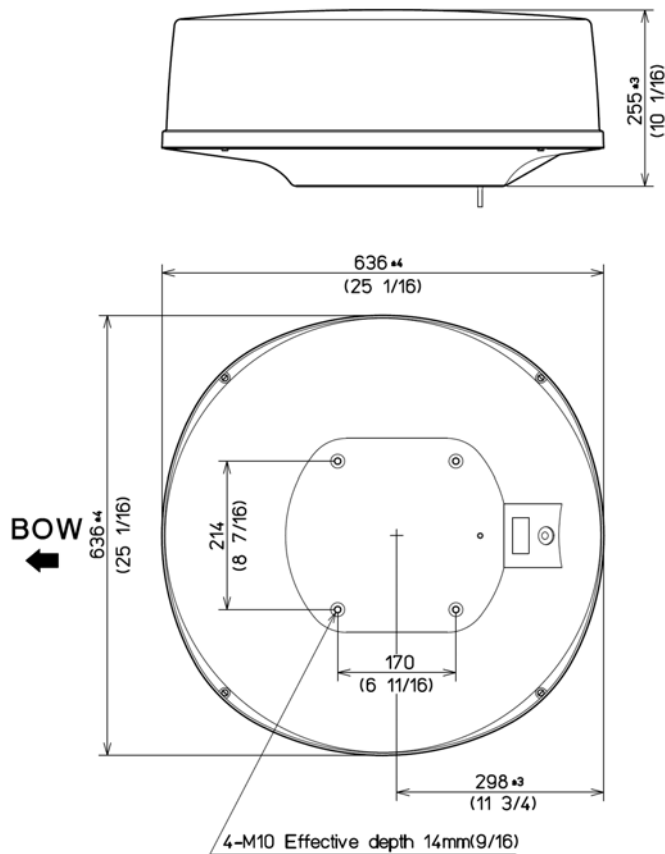

Weight: 10kg (22.5lb)

RB716A

Unit: mm (inch)

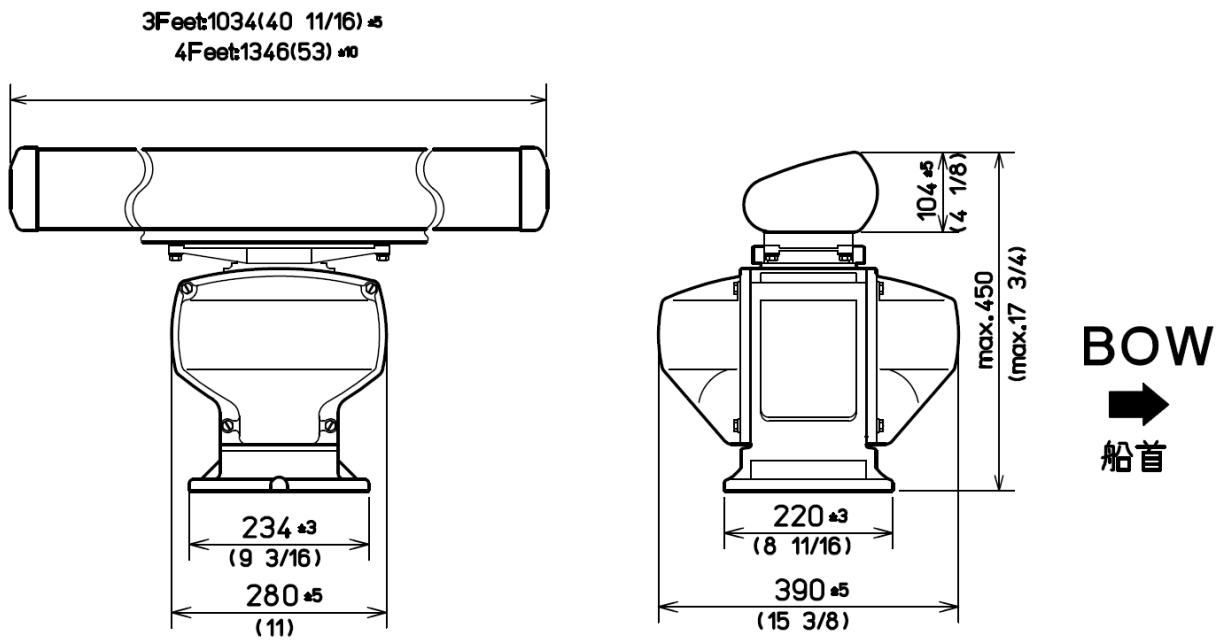

Weight : 21.5kg/(47lb) . . . 3Feet(RW701A-03)  
22.5kg/(50lb) . . . 4Feet(RW701A-04)



## Chapter 7 Principle of radar system

### 7.1 What is the radar system?

The radar system is a navigation device that transmits a very high frequency radio wave referred as microwave from antenna. The radar then receives the radio wave reflected by target(s) (e.g. other ship, buoy, island, etc) via the same antenna and converts the received radio wave to electronic signals and sends these signals to the display unit. The radar makes it possible to find objects (targets), such as other ships, rocks or coastline, not seen by eyesight or in fog and allows ships to avoid these potential hazards.

As the antenna transmits while rotating, it is possible to see the current surrounding situation around your ship at a glance.

The microwave radiated from the radar is referred as pulse wave and transmitting and receiving of these waves alternate. Up to thousands of pulse waves are transmitted and received during one 360 degree rotation.

The typical radar antenna is a parabolic type or slotted array and its performance is essential for good radar performance. Some of factors affecting the quality of the target returns are the antenna beam width and the side lobe level. The narrow beam width provides a high resolution for angular orientation to distinguish objects and the low side lobe level reduces a false image effect.

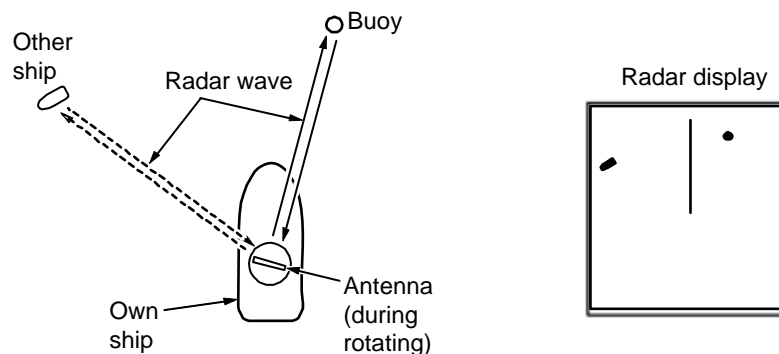

Figure 7-1 What is Radar?

### Side lobe

The main lobe means the strongest radiated beam sent from the specific antenna, and the other weaker beams, are referred as side lobes. A side lobe level is a difference between the largest side lobe level and main lobe level.

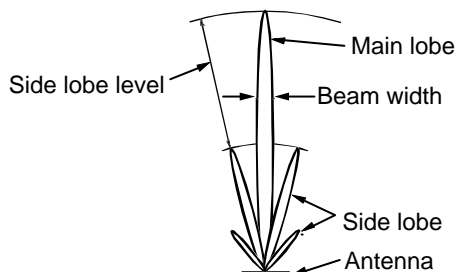

Figure 7-2 Antenna pattern

### Beam width

The antenna beam width is defined as the angle where the radiation power density is within a half of the maximum power supply in the main lobe (also, referred as “half” value width”).

## 7.2 Characteristics of radar radio wave

The radio wave propagates slightly along the ground (primarily line of sight). This characteristic varies depending on the density of atmosphere but generally calculated according to the formula as shown below, considering that the distance with radar sight  $D$  is about 6% longer than the distance with optical sight.

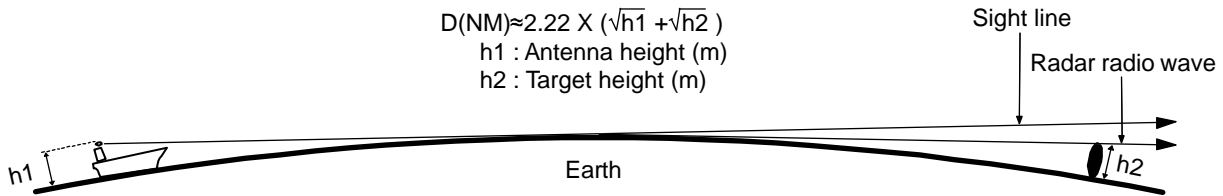

Figure 7-3 Characteristics of radar radio wave

### Target with less reflection

The strength of the reflected waves from a target varies depending on not only the distance from the target, its height or size, but also (radar absorbing) material and shapes. A target with a low degree of reflection or low incident angle, such as FRP and wooden is not reflected well. Therefore, care should be taken that a FRP ship, a wooden ship or an object such as sand, a sandbar and muddy cay poor radar targets.

Since the distance from the coastline, etc. to your ship on a radar image to be seen as longer than that from the actual coastline, more caution should be used navigating around such objects.

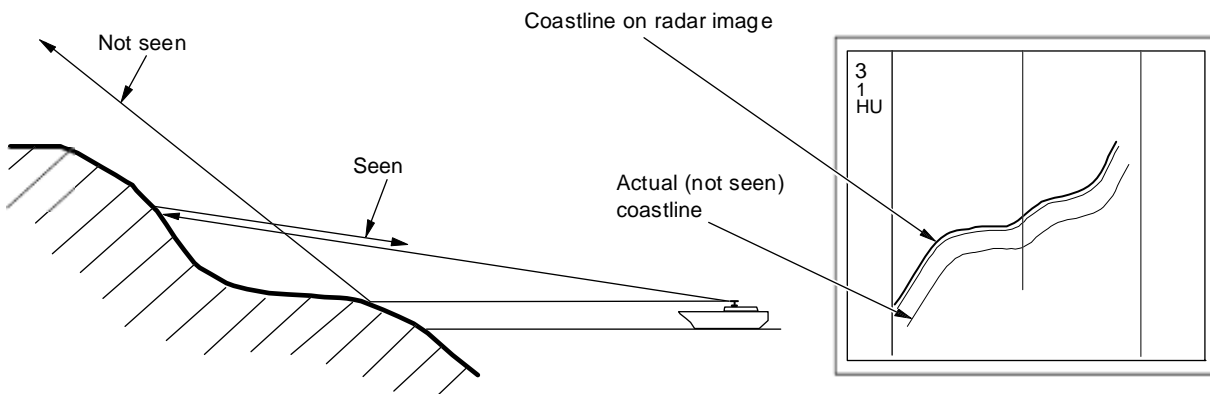

Figure 7-4 Example of targets hard to be reflected

### Radar shadow

Since the radar radio wave propagates straightly, your ship's chimney stack and mast close to the antenna, a large ship or mountain can create blind spots for which the radar wave cannot penetrate. In such cases, they may completely or partially hide targets and cast a long shadow.

Since the shadow your ship's chimney stack or mast is known at the time of installation, proper selection of the antenna location is required to reduce the shadow effect. Since targets less likely to be in this shadow area than in open sea, an extra attention should be taken in shadow areas.

### False image

An image that does not actually exist (false image) at sea may appear on the display.

The phenomenon that causes false echoes are categorized and be described as follows:

● **Virtual image**

The image of a large physical object in a close proximity may appear in two different orientations. One is a real image and the other is a false image caused by wave reflected on the chimney stack or the mast, etc.

On the display, one image appears with a right distance and bearing, and another one appears in the direction of chimney stack, mast, etc. These images may also be generated by being reflected multiple times from the bridges and quays too.

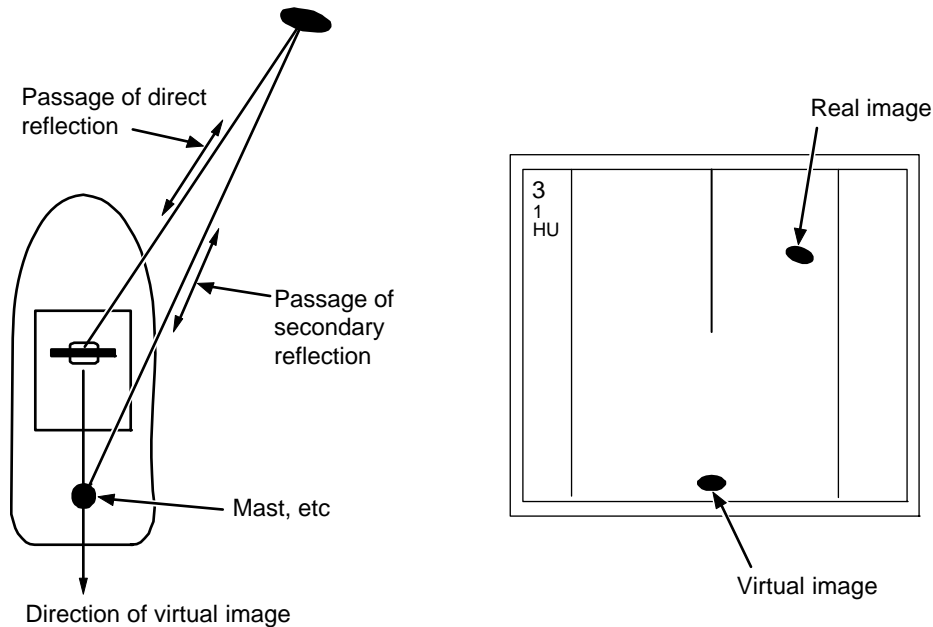

Figure 7-5 False image by virtual image

● **Duplicate target images**

When there is a big reflective surface nearby and perpendicular at a close distance (i.e. when your ship is passed by a big ship, etc.) radio wave bounces repeatedly between your ship and the other ship. Therefore, 2 to 4 images may appear at equal range in the direction of this target. The false image generated by this multi-path reflection is referred as “double targets”. In this case, the closest target is the real one.

Even if the double targets appear, if the distance and bearing between own ship and the reflective target changes, the duplicate targets will disappear. Therefore, this false image can be easily distinguished.

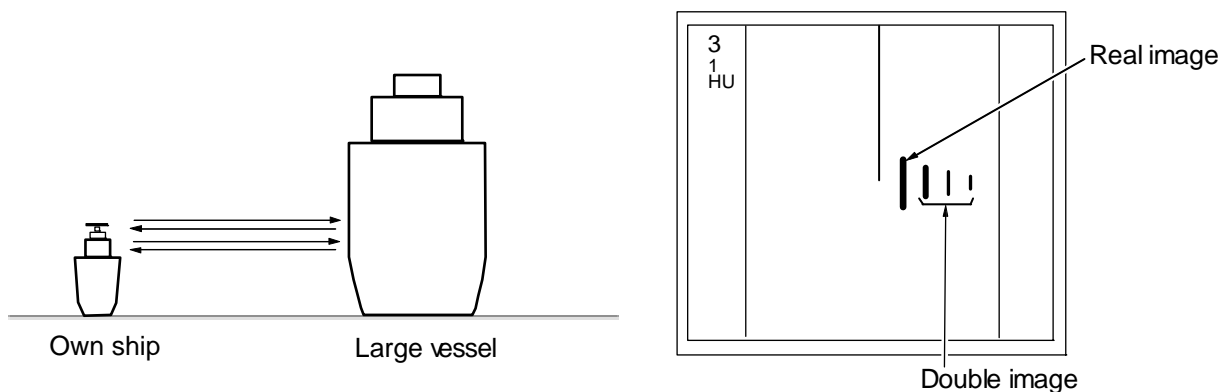



Figure 7-6 False image caused by double image

● **False image by sidelobe**

The microwave beam radiated from the antenna has a side lobe in different direction than that of the main beam. Since this side lobe is lower than that of main beam, the effect is negligible for targets at a long range, but a close, strong reflecting target may cause false image in a circular arc shape.

	<p><b>Caution</b> If a large target such as land exists near your ship, a circular arc shaped image may appear.</p>
---	---

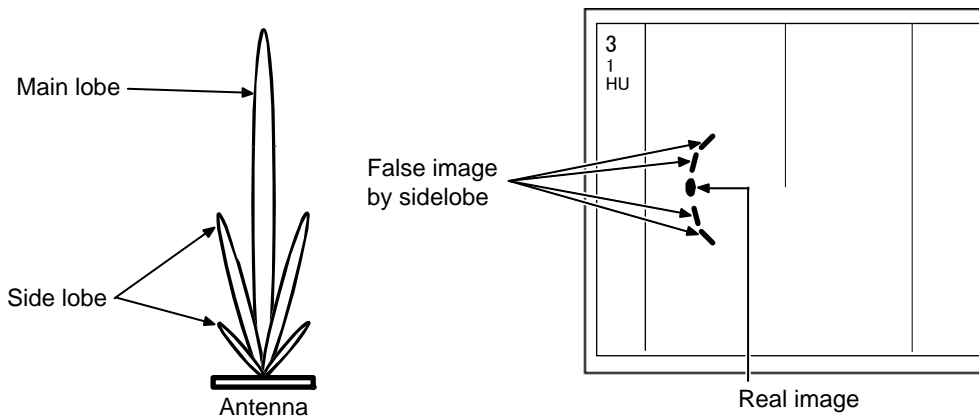

Figure 7-7 False image by sidelobe

● **False image of a distant target caused by “duct”**

Depending on a weather conditions, a duct occurs by the temperature inversion, etc. In this case, the unusual propagation of the radio wave may reach distant targets out of radar range. A target at more than the maximum range may appear as an image, and may be displayed as a false image closer than an actual distance. This phenomenon is a result of the long range echo delay time exceeds the transmission period, and is displayed as the echo in the next cycle. When changing the range of a distance, if the distance of the target changes, it can be judged as a false image.

**7.3 Radar interference**

When the radar with the same frequency band is used nearby, interference noise appears on a display. Although appearance of interference is not constant, the shape is almost always swirling or radial. This device features an interference rejection facility to reduce interference.





## Koden Electronics Co., Ltd.

**Tamagawa Office:**

2-13-24 Tamagawa, Ota-ku, Tokyo, 146-0095 Japan

Tel: +81-3-3756-6501 Fax: +81-3-3756-6509

**Uenohara Office:**

5278 Uenohara, Uenohara-shi, Yamanashi, 409-0112 Japan

Tel: +81-554-20-5860 Fax: +81-554-20-5875

**[www.koden-electronics.co.jp](http://www.koden-electronics.co.jp)**