

### SPECIFICATIONS

#### Antenna-scanner unit

Model	MDC-2240 RB716A	MDC-2260 RB717A	MDC-2210 RB718A	MDC-2220 RB719A
Antenna type	Open antenna			
Antenna length	3 feet	4 feet	4 feet	6 feet
Power output (Peak)	4 kW	6 kW	12 kW	25 kW
Output frequency	9410 MHz to 30 MHz			
Horizontal beam width	2.5°	1.8°	1.8°	0.8°
Vertical beam width	22°			25°
Rotation	24 rpm or 48 rpm			
IF center frequency	60 MHz			
Range accuracy	8 meters or 1% of the range scale selected, whichever is the greater			
Bearing accuracy	1° or less			
Minimum detecting distance	Within 25 m			
Range resolution	Within 25 m			
Pulse width	0.08 us, 0.25 us, 0.8 us	0.08 us, 0.25 us, 0.5 us, 1 us	0.08 us, 0.3 us, 0.6 us, 1.2 us	
<b>Environmental</b>				
Operating temperature	-25°C to +55°C			
Water Protection	IPX6			

#### Display unit / Processor unit for BB type

Model	MDC-2240/2260/2210/2220	MDC-2540/2560/2510/2520
Display unit	MRD-101	MRD-102 (Deselect BB type)
Display size / type	12.1" color TFT LCD	15" color TFT LCD (Deselect BB type)
Processor unit (BB type only)	-	MRM-102
Effective diameter	184 mm	228 mm
Display resolution	1024 x 768 pixels (XGA)	
Off-centering	Max. 66%	
Echo area	2 types (Full screen, inside of effective diameter)	

Model	MDC-2240, 2540/BB	MDC-2260, 2560/BB	MDC-2210, 2510/BB	MDC-2220, 2520/BB
Basic Range	0.125 to 48 NM	0.125 to 72 NM	0.125 to 96 NM	0.125 to 96 NM
Range Scales	0.125, 0.25, 0.5, 1, 1.5, 2, 3, 4, 6, 8, 12, 16, 24, 32, 48, 64, 72, 96			
Range Interval	0.0625, 0.125, 0.25, 0.5, 1.0, 1.5, 2, 3, 4, 6, 8, 12, 16, 18, 24			
Presentation modes	Head-up, North-up*, Course-up*			
Indication system	PPI			
Video levels	8 levels (colors)			
Range unit	NM, km, sm			
Alarms	Echo (IN / OUT), ATA / AIS (CPA / TCPA), Guard zone etc.			
Functions	Interference rejection, Target expansion, Zoom, 2 VRM, 2 EBL (true/relative), Floating EBL / VRM, Cursor position (Lat / Lon**), Parallel cursor, Day / Night mode, Bearing (true/relative), Trail**, Past course**, Mark**, Route**, RGB Monitor output, Slave display monitor input / output, External Buzzer output			
Input data format and sentences	NMEA 0183 Ver.1.5/2.0/3.0 BWC, DBT, DTM, GGA, GLL, GNS, HDG, HDM, HDT, MTW, RMA, RMB, RMC, RTE, VBM, VDR, VHW, VTG, WPL, ZDA			
Output data format and sentences	NMEA 0183 Ver.2.0 HDT, VHW, VTG, GLL, VDR, RSD, OSD, TTM, TLL			
NMEA ports	3 (input 1, input / output 2)			
AIS interface**	200 targets (Option)			
ATA**	50 targets			
Power supply	10.8 to 41.6 VDC			
Power Consumption (at 24VDC)	MDC-2240: 80 W or less MDC-2540: 100 W or less MDC-2540BB: 80 W or less	MDC-2260: 110 W or less MDC-2560: 130 W or less MDC-2560BB: 110 W or less	MDC-2210: 130 W or less MDC-2510: 150 W or less MDC-2510BB: 130 W or less	MDC-2220: 170 W or less MDC-2520: 200 W or less MDC-2520BB: 180 W or less
<b>Environmental</b>				
Operating temperature	-15°C to +55°C			
Water Protection	IPX 5 (BB type with optional water protection RGB cable)			

\* Requires bearing data input.  
\*\* Requires bearing data, ship's speed data and latitude / longitude data input.

### CONNECTIONS

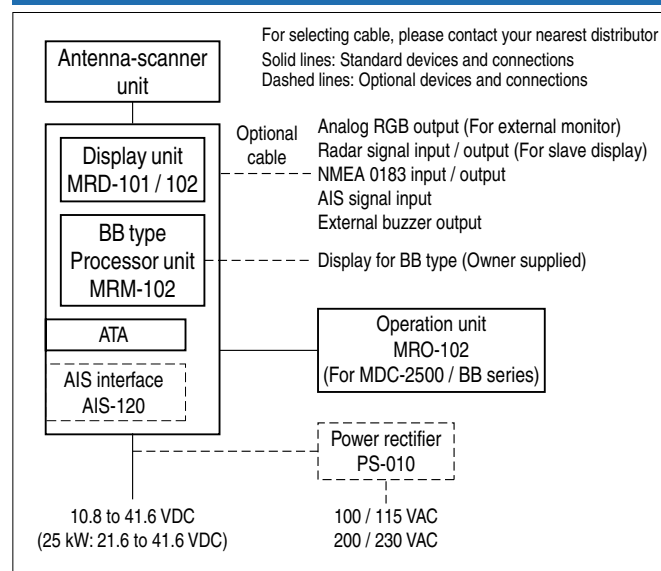

### EQUIPMENT LIST

#### Standard Equipment

Antenna-scanner unit	Scanner RB716A	4 kW	MDC-2240, 2540 / BB
	RB717A	6 kW	MDC-2260, 2560 / BB
	RB718A	12 kW	MDC-2210, 2510 / BB
	RB719A	25 kW	MDC-2220, 2520 / BB
Antenna unit	RW701A-03	3 feet	MDC-2240, 2540 / BB
	RW701A-04	4 feet	MDC-2240, 2260, 2210, 2540 / BB, 2560 / BB, 2510 / BB
	RW701A-06	6 feet	MDC-2260, 2210, 2520, 2560 / BB, 2510 / BB, 2520 / BB
	RW701B-09	9 feet	MDC-2220, 2520 / BB
Display unit (Deselect BB type)	MRD-101	MDC-2200 series	
	MRD-102	MDC-2500 series	
Operation unit	MRO-102	MDC-2500 / BB series	
Processor unit	MRM-102	MDC-2500BB series	
Connecting cable	242J159098B-15M	15 m	
DC power cable	CW-259-2M	2 m	

Operation manual, Quick reference, Installation manual, Installation material, Spare parts

#### Option

AIS interface, Gyro-Log interface, Power rectifier, AC power cable, Water protection RGB cable

### DIMENSIONS AND WEIGHT

#### Display unit:

##### MRD-101 (MDC-2200 series)

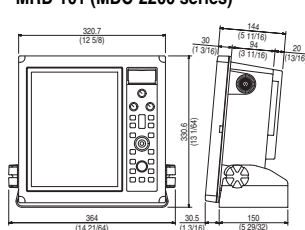

Weight: 8.2 kg (18 lb)

##### MRD-102 (MDC-2500 series)

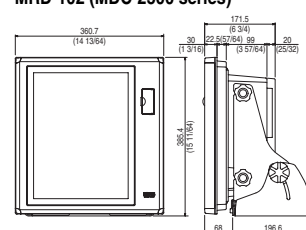

Weight: 12.5 kg (27.5 lb)

#### Operation unit:

##### MRO-102 (MDC-2500 / BB series)

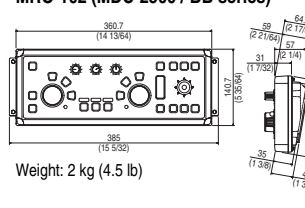

Weight: 2 kg (4.5 lb)

#### Processor unit:

##### MRM-102 (MDC-2500BB series)

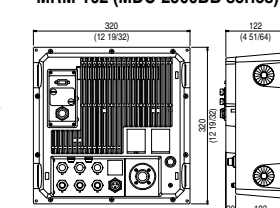

Weight: 5.1 kg (11.2 lb)

#### Antenna-scanner unit:

##### RB716A / RB717A / RB718A with RW701A-03 / 04 / 06

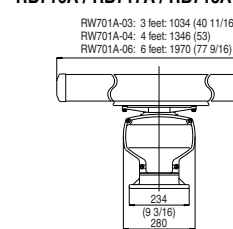

Weight:  
RB716A  
3 feet: 21 kg (46 lb)  
4 feet: 22 kg (49 lb)  
RB717A / 718A  
4 feet: 23 kg (51 lb)  
6 feet: 25 kg (56 lb)

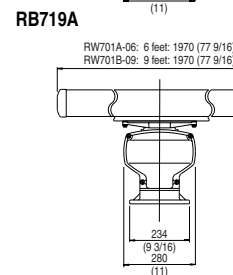

Weight:  
RB719A  
6 feet: 29 kg (64 lb)  
9 feet: 33 kg (73 lb)

Unit: mm (inch)

• Design and specifications are subject to change without notice.



**Safety precaution** To ensure proper and safe use of the equipment, please carefully read and follow the instructions in the Operation Manual.

For details, please contact:



# High-end Radar series forming a class apart!

MDC-2200 / 2500 series are high performance and multi-function Radars with the essence of Koden's advanced technology.

In all phases including accuracy, stability, and reliability, the series achieve the highest-grade in the market. MDC-2500BB Black Box radars connect to any XGA or UXGA type display\* (owner supplied).

\* Monitors other than XGA / UXGA should have "Aspect" function to avoid improper image presentation.

## Wide variation

Offered with two display sizes, a 12-inch display with operation panel housed in a single compact case and a convenient two piece 15-inch unit with separate keyboard for multiple installation locations. Both units have high-resolution XGA (1024 x 768) grade LCD, which is extraordinary for the 12-inch LCD display.

Antenna-Scanner Units are selectable from a wide variety of output powers and lengths to best fit your application or site circumstances.

Black Box models also available.

### ● 12-inch (The highest resolution of the class)

MDC-2240: 4 kW, 3 feet / 4 feet Open

MDC-2260: 6 kW, 4 feet / 6 feet Open

MDC-2210: 12 kW, 4 feet / 6 feet Open

MDC-2220: 25 kW, 6 feet / 9 feet Open

### ● 15-inch

MDC-2540: 4 kW, 3 feet / 4 feet Open

MDC-2560: 6 kW, 4 feet / 6 feet Open

MDC-2510: 12 kW, 4 feet / 6 feet Open

MDC-2520: 25 kW, 6 feet / 9 feet Open

### ● Black Box

MDC-2540BB: 4 kW, 3 feet / 4 feet Open

MDC-2560BB: 6 kW, 4 feet / 6 feet Open

MDC-2510BB: 12 kW, 4 feet / 6 feet Open

MDC-2520BB: 25 kW, 6 feet / 9 feet Open

## True trail function

The display shows exact movement of other vessels like drawing tails, while land and buoys are shown as stationary objects even while your vessel is moving.

This makes it easy for you to distinguish moving from stationary objects.

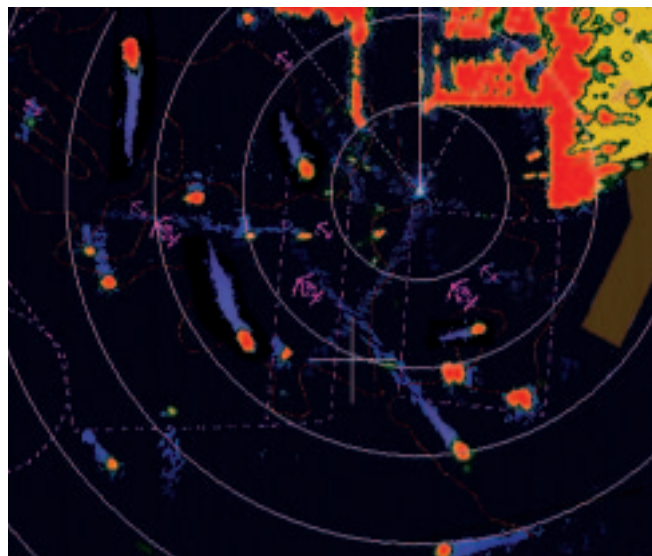

## ATA with up to 50 targets as standard

The convenient ATA (Automatic Tracking Aid) function comes as standard.

The latest movements of other vessels can be shown instantaneously in vector form and numeric form, ensuring safe navigation.

If the automatic acquisition zone is set, the targets up to 50 entering the zone will be locked automatically.

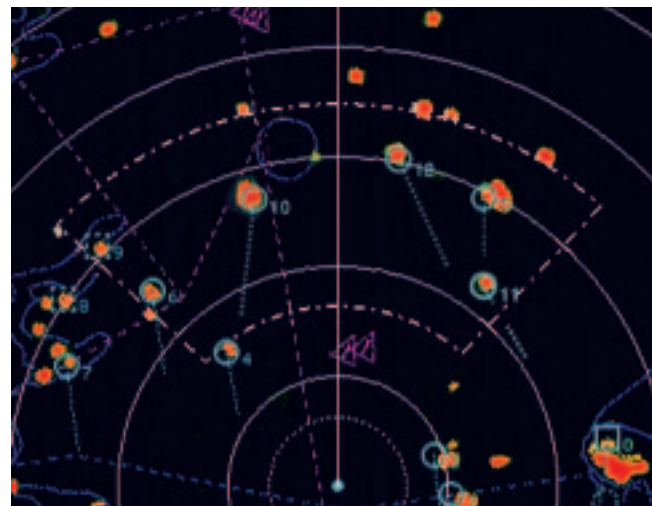

## AIS interface up to 200 targets as option

When connected with an AIS receiver, the radar displays information on up to 200 targets including the vessel name, heading, and speed of each vessel with an AIS transmitter mounted.

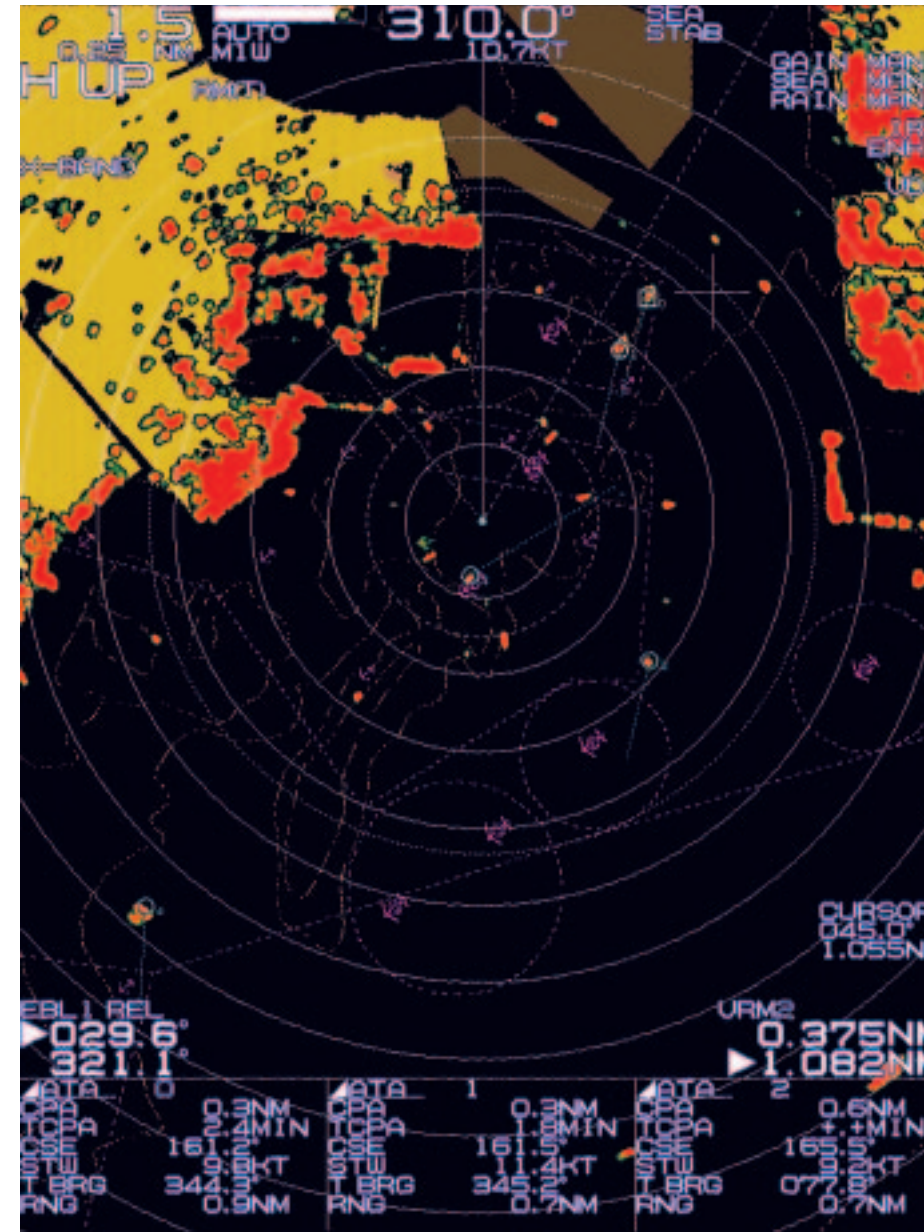
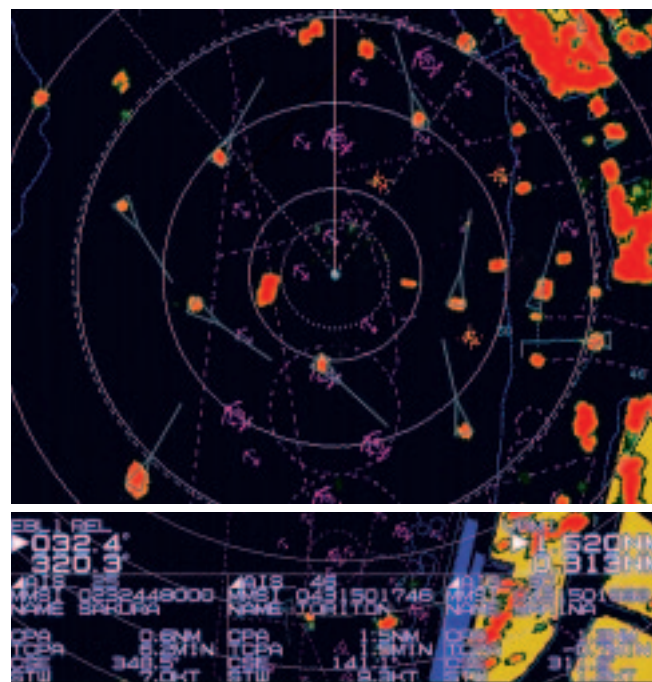

## Map Overlay with C-Map chart (NT+ or NT MAX)

C-Map chart NT+ or NT MAX (owner supplied) is overlaid on the radar screen to provide clear radar pictures of coastlines, buoys, and other features.\*\*

Even in Head-up mode, the chart follows smoothly in accordance with change of the heading of vessel.

Furthermore, waypoints, buoys, and hazardous targets can be overlaid for safer navigation.

C-Map NT MAX "World Wide" background chart is built-in as standard.

\*\* Basic chart information only. Extra features of C-Map such as photo indication are not available.

## Slave display

One antenna can be operated from two displays. This is highly effective for navigation of a double ended vessel with bridges in the bow and stern.

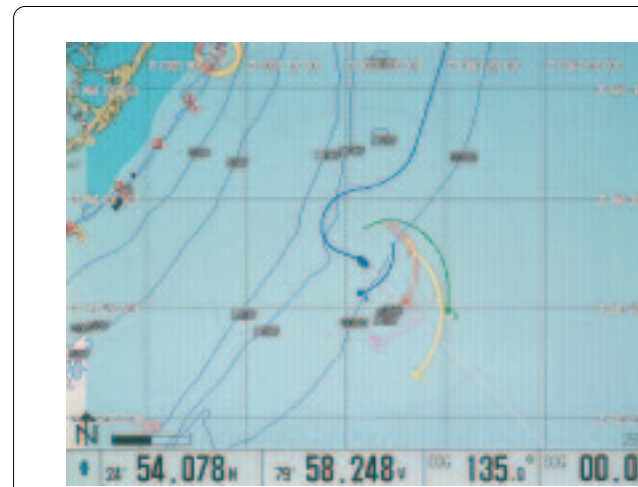

## Display of other vessels' tracks to plotter screen

When connected with a Koden Chart Plotter, other vessels' tracks locked with the ATA can be plotted on the screen of plotter.

You can get other ships' movements at a glance with this function, which is highly useful and effective for group fishing operation.

The number of the track plots depends on specification of plotter.

Display example with Koden Chart Plotter GTD-110 / 150